

The Fundamentals of Modal Testing

Application Note 243 - 3

$$H(\omega) = \sum_{r=1}^n \frac{\phi_r \phi_j / m}{\sqrt{(\omega_n^2 - \omega^2)^2 + (2\xi\omega\omega_n)^2}}$$



Agilent Technologies
Innovating the HP Way

Preface

Modal analysis is defined as the study of the dynamic characteristics of a mechanical structure. This application note emphasizes experimental modal techniques, specifically the method known as frequency response function testing. Other areas are treated in a general sense to introduce their elementary concepts and relationships to one another.

Although modal techniques are mathematical in nature, the discussion is inclined toward practical application. Theory is presented as needed to enhance the logical development of ideas. The reader will gain a sound physical understanding of modal analysis and be able to carry out an effective modal survey with confidence.

Chapter 1 provides a brief overview of structural dynamics theory. Chapter 2 and 3 which is the bulk of the note – describes the measurement process for acquiring frequency response data. Chapter 4 describes the parameter estimation methods for extracting modal properties. Chapter 5 provides an overview of analytical techniques of structural analysis and their relation to experimental modal testing.

Table of Contents

Preface	2
Chapter 1 — Structural Dynamics Background	4
Introduction	4
Structural Dynamics of a Single Degree of Freedom (SDOF) System	5
Presentation and Characteristics of Frequency Response Functions	6
Structural Dynamics for a Multiple Degree of Freedom (MDOF) System	9
Damping Mechanism and Damping Model	11
Frequency Response Function and Transfer Function Relationship	12
System Assumptions	13
Chapter 2 — Frequency Response Measurements	14
Introduction	14
General Test System Configurations	15
Supporting the Structure	16
Exciting the Structure	18
Shaker Testing	19
Impact Testing	22
Transduction	25
Measurement Interpretation	29
Chapter 3 — Improving Measurement Accuracy	30
Measurement Averaging	30
Windowing Time Data	31
Increasing Measurement Resolution	32
Complete Survey	34
Chapter 4 — Modal Parameter Estimation	38
Introduction	38
Modal Parameters	39
Curve Fitting Methods	40
Single Mode Methods	41
Concept of Residual Terms	43
Multiple Mode-Methods	45
Concept of Real and Complex Modes	47
Chapter 5 — Structural Analysis Methods	48
Introduction	48
Structural Modification	49
Finite Element Correlation	50
Substructure Coupling Analysis	52
Forced Response Simulation	53
Bibliography	54

Chapter 1

Structural Dynamics Background

Introduction

A basic understanding of structural dynamics is necessary for successful modal testing. Specifically, it is important to have a good grasp of the relationships between frequency response functions and their individual modal parameters illustrated in Figure 1.1. This understanding is of value in both the measurement and analysis phases of the survey. Knowing the various forms and trends of frequency response functions will lead to more accuracy during the measurement phase. During the analysis phase, knowing how equations relate to frequency responses leads to more accurate estimation of modal parameters.

The basic equations and their various forms will be presented conceptually to give insight into the relationships between the dynamic characteristics of the structure and the corresponding frequency response function measurements. Although practical systems are multiple degree of freedom (MDOF) and have some degree of nonlinearity, they can generally be represented as a superposition of single degree of freedom (SDOF) linear models and will be developed in this manner.

First, the basics of an SDOF linear dynamic system are presented to gain insight into the single mode concepts that are the basis of some parameter estimation techniques. Second, the presentation and properties of various forms of the frequency response function are examined to understand

Figure 1.1
Phases of a modal test

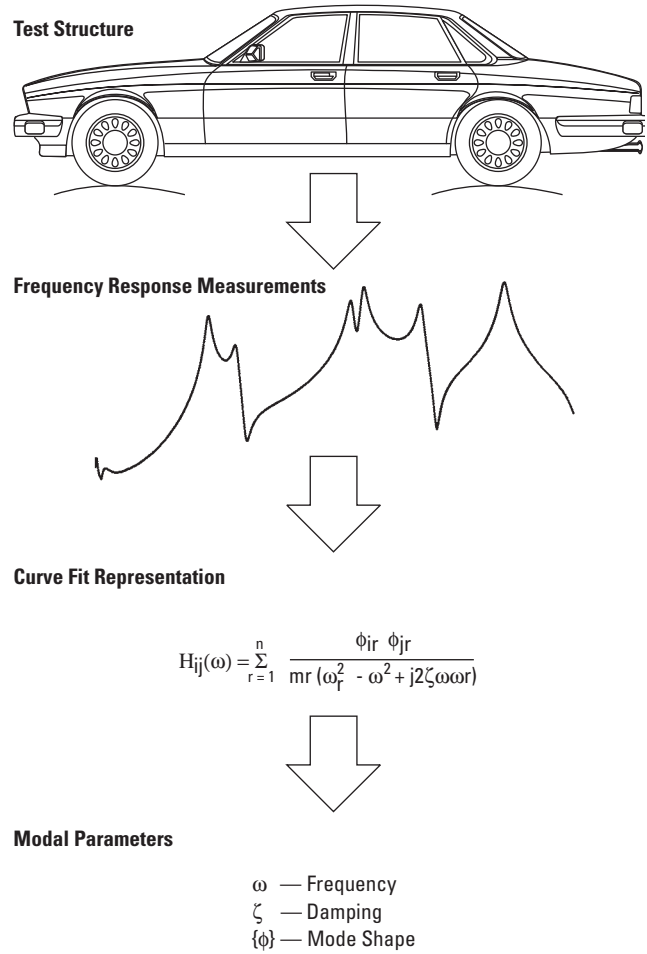

the trends and their usefulness in the measurement process. Finally, these concepts are extended into MDOF systems, since this is the type of behavior most physical structures exhibit. Also, useful concepts associated with damping mechanisms and linear system assumptions are discussed.

Structural Dynamics of a Single Degree of Freedom (SDOF) System

Although most physical structures are continuous, their behavior can usually be represented by a discrete parameter model as illustrated in Figure 1.2. The idealized elements are called mass, spring, damper and excitation. The first three elements describe the physical system. Energy is stored by the system in the mass and the spring in the form of kinetic and potential energy, respectively. Energy enters the system through excitation and is dissipated through damping.

The idealized elements of the physical system can be described by the equation of motion shown in Figure 1.3. This equation relates the effects of the mass, stiffness and damping in a way that leads to the calculation of natural frequency and damping factor of the system. This computation is often facilitated by the use of the definitions shown in Figure 1.3 that lead directly to the natural frequency and damping factor.

The natural frequency, ω , is in units of radians per second (rad/s). The typical units displayed on a digital signal analyzer, however, are in Hertz (Hz). The damping factor can also be represented as a percent of critical damping – the damping level at which the system experiences no oscillation. This is the more common understanding of modal damping. Although there are three distinct damping cases, only the underdamped case ($\zeta < 1$) is important for structural dynamics applications.

Figure 1.2 SDOF discrete parameter model

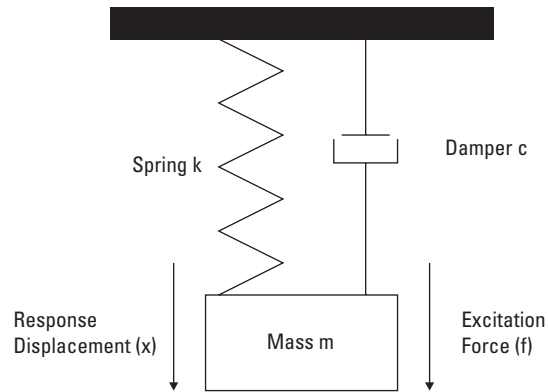

Figure 1.3 Equation of motion — modal definitions

$$m\ddot{x} + c\dot{x} + kx = f(t)$$

$$\omega_n^2 = \frac{k}{m}, \quad 2\zeta\omega_n = \frac{c}{m} \quad \text{or} \quad \zeta = \frac{c}{\sqrt{2km}}$$

Figure 1.4 Complex roots of SDOF equation

$$s_{1,2} = -\sigma + j\omega_d$$

σ — Damping Rate
 ω_d — Damped Natural Frequency

Figure 1.5 SDOF impulse response/free decay

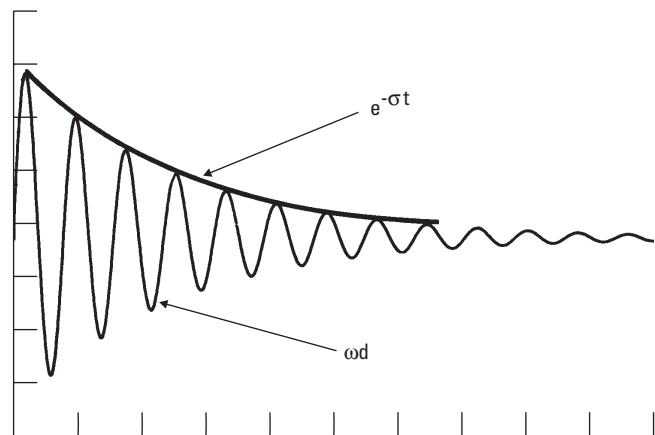

When there is no excitation, the roots of the equation are as shown in Figure 1.4. Each root has two parts: the real part or decay rate, which defines damping in the system and the imaginary part, or oscillatory rate, which defines the damped natural frequency, ω_d . This free vibration response is illustrated in Figure 1.5.

When excitation is applied, the equation of motion leads to the frequency response of the system. The frequency response is a complex quantity and contains both real and imaginary parts (rectangular coordinates). It can be presented in polar coordinates as magnitude and phase, as well.

Presentation and Characteristics of Frequency Response Functions

Because it is a complex quantity, the frequency response function cannot be fully displayed on a single two-dimensional plot. It can, however, be presented in several formats, each of which has its own uses. Although the response variable for the previous discussion was displacement, it could also be velocity or acceleration. Acceleration is currently the accepted method of measuring modal response.

One method of presenting the data is to plot the polar coordinates, magnitude and phase versus frequency as illustrated in Figure 1.6. At resonance, when $\omega = \omega_n$, the magnitude is a maximum and is limited only by the amount of damping in the system. The phase ranges from 0° to 180° and the response lags the input by 90° at resonance.

Figure 1.6
Frequency response — polar coordinates

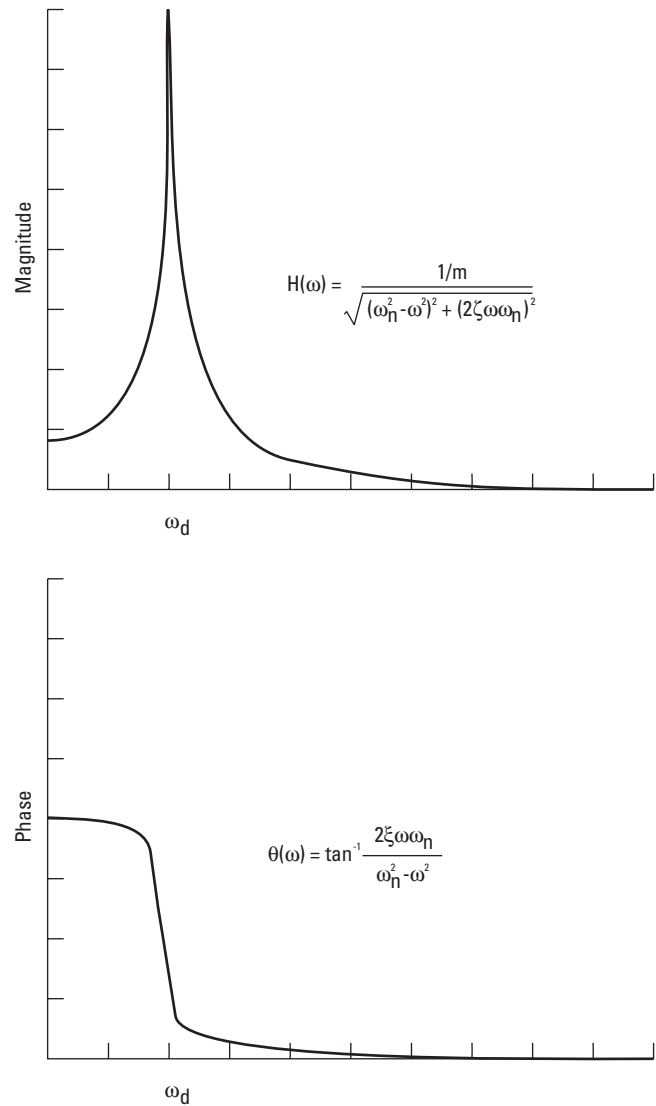

Another method of presenting the data is to plot the rectangular coordinates, the real part and the imaginary part versus frequency. For a proportionally damped system, the imaginary part is maximum at resonance and the real part is 0, as shown in Figure 1.7.

A third method of presenting the frequency response is to plot the real part versus the imaginary part. This is often called a Nyquist plot or a vector response plot. This display emphasizes the area of frequency response at resonance and traces out a circle, as shown in Figure 1.8.

By plotting the magnitude in decibels vs logarithmic (log) frequency, it is possible to cover a wider frequency range and conveniently display the range of amplitude. This type of plot, often known as a Bode plot, also has some useful parameter characteristics which are described in the following plots.

When $\omega \ll \omega_n$ the frequency response is approximately equal to the asymptote shown in Figure 1.9. This asymptote is called the stiffness line and has a slope of 0, 1 or 2 for displacement, velocity and acceleration responses, respectively. When $\omega \gg \omega_n$ the frequency response is approximately equal to the asymptote also shown in Figure 1.9. This asymptote is called the mass line and has a slope of -2, -1 or 0 for displacement velocity or acceleration responses, respectively.

Figure 1.7
Frequency response — rectangular coordinates

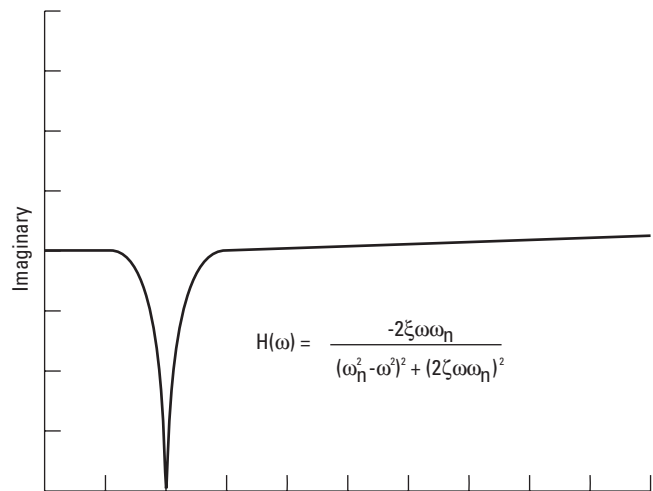
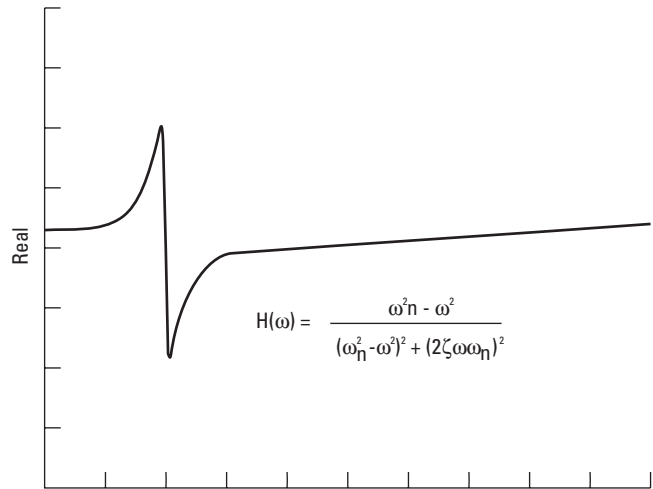
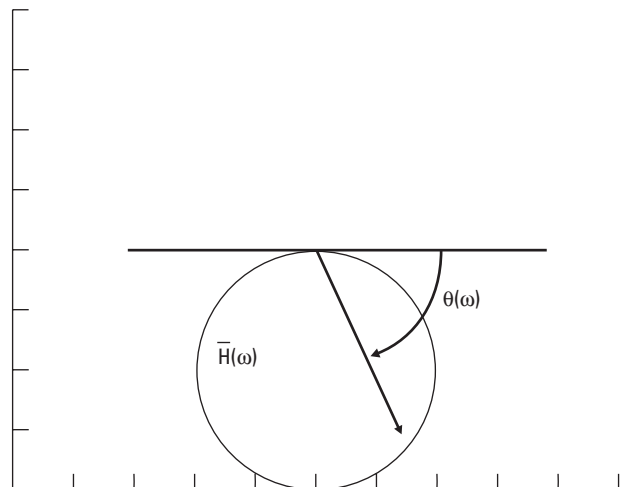

Figure 1.8
Nyquist plot of frequency response



The various forms of frequency response function based on the type of response variable are also defined from a mechanical engineering viewpoint. They are somewhat intuitive and do not necessarily correspond to electrical analogies. These forms are summarized in Table 1.1.

Table 1.1
Different forms of frequency response

Definition	Response	Variable
Compliance	$\frac{X}{F}$	$\frac{\text{Displacement}}{\text{Force}}$
Mobility	$\frac{V}{F}$	$\frac{\text{Velocity}}{\text{Force}}$
Accelerance	$\frac{A}{F}$	$\frac{\text{Acceleration}}{\text{Force}}$

Figure 1.9
Different forms of frequency response

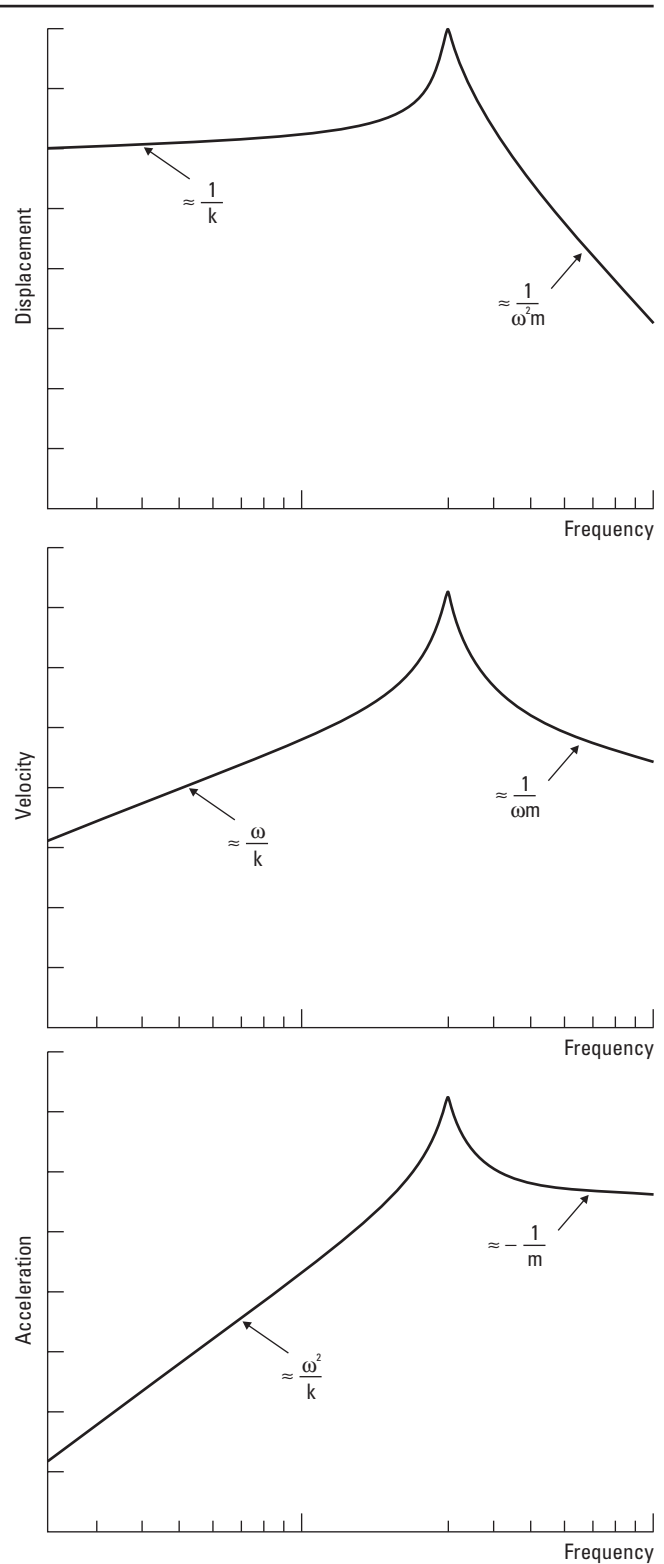

Structural Dynamics for a Multiple Degree of Freedom (MDOF) System

The extension of SDOF concepts to a more general MDOF system, with n degrees of freedom, is a straightforward process. The physical system is simply comprised of an interconnection of idealized SDOF models, as illustrated in Figure 1.10, and is described by the matrix equations of motion as illustrated in Figure 1.11.

The solution of the equation with no excitation again leads to the modal parameters (roots of the equation) of the system. For the MDOF case, however, a unique displacement vector called the mode shape exists for each distinct frequency and damping as illustrated in Figure 1.11. The free vibration response is illustrated in Figure 1.12.

The equations of motion for the forced vibration case also lead to frequency response of the system. It can be written as a weighted summation of SDOF systems shown in Figure 1.13.

The weighting, often called the modal participation factor, is a function of excitation and mode shape coefficients at the input and output degrees of freedom.

Figure 1.10
MDOF discrete parameter model

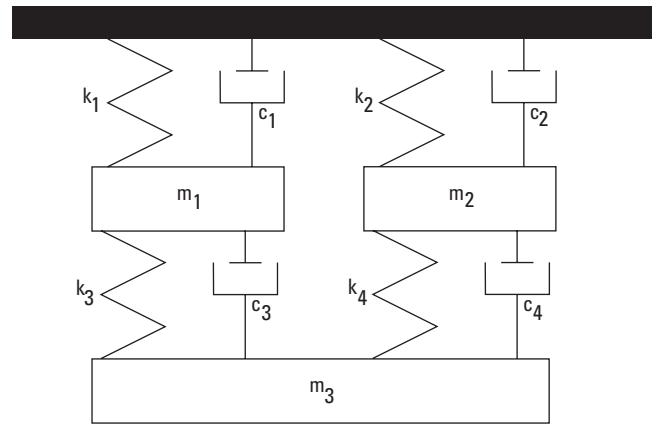
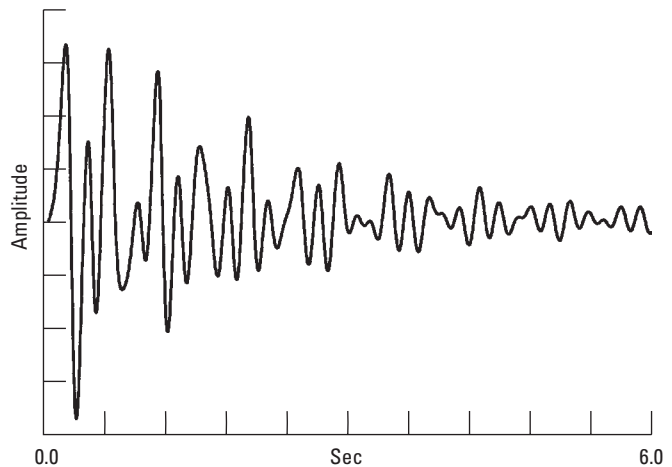

Figure 1.11
Equations of motion — modal definitions

$$[m]\{\ddot{x}\} + [c]\{\dot{x}\} + [k]\{x\} = \{f(t)\}$$

$$\{\phi\}_r, r = 1, n \text{ modes}$$

Figure 1.12
MDOF impulse response/free decay



The participation factor identifies the amount each mode contributes to the total response at a particular point. An example with 3 degrees of freedom showing the individual modal contributions is shown in Figure 1.14.

The frequency response of an MDOF system can be presented in the same forms as the SDOF case. There are other definitional forms and properties of frequency response functions, such as a driving point measurement, that are presented in the next chapter. These are related to specific locations of frequency response measurements and are introduced when appropriate.

Figure 1.13
MDOF frequency response

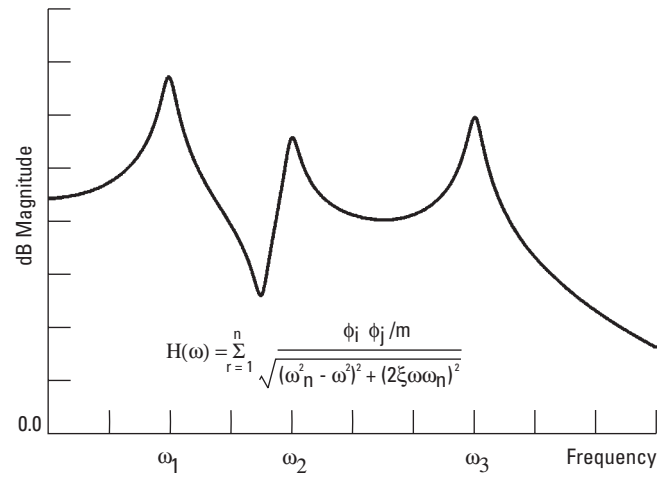
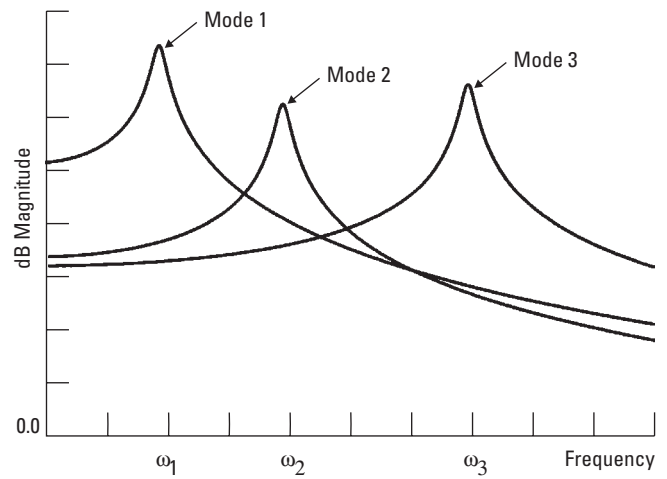

Figure 1.14
SDOF modal contributions



Damping Mechanism and Damping Model

Damping exists in all vibratory systems whenever there is energy dissipation. This is true for mechanical structures even though most are inherently lightly damped. For free vibration, the loss of energy from damping in the system results in the decay of the amplitude of motion. In forced vibration, loss of energy is balanced by the energy supplied by excitation. In either situation, the effect of damping is to remove energy from the system.

In previous mathematical formulations the damping force was called viscous, since it was proportional to velocity. However, this does not imply that the physical damping mechanism is viscous in nature. It is simply a modeling method and it is important to note that the physical damping mechanism and the mathematical model of that mechanism are two distinctly different concepts.

Most structures exhibit one or more forms of damping mechanisms, such as coulomb or structural, which result from looseness of joints, internal strain and other complex causes. However, these mechanisms can be modeled by an equivalent viscous damping component. It can be shown that only the viscous component actually accounts for energy loss from the system and the remaining portion of the damping is due to nonlinearities that do not cause energy dissipation. Therefore, only the viscous term needs to be measured to characterize the system when using a linear model.

The equivalent viscous damping coefficient is obtained from energy considerations as illustrated in the

Figure 1.15
Viscous damping energy dissipation

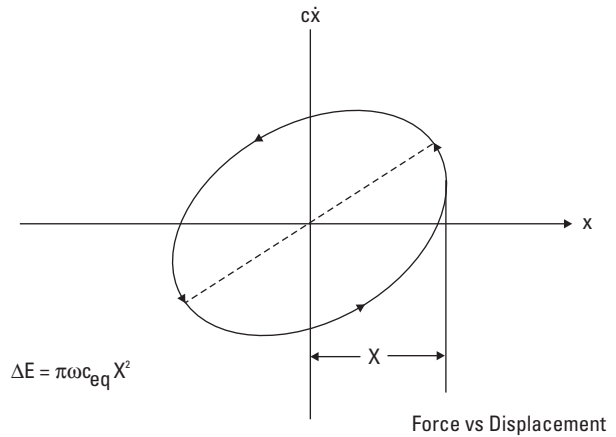

Figure 1.16
System block diagram

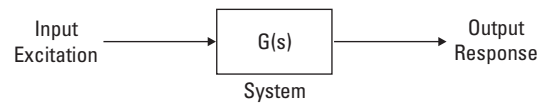

Figure 1.17
Definition of transfer function

$$\text{Transfer Function} = \frac{\text{Output}}{\text{Input}}$$

$$G(s) = \frac{Y(s)}{X(s)}$$

hysteresis loop in Figure 1.15. E is the energy dissipated per cycle of vibration, c_{eq} is the equivalent viscous damping coefficient and X is the amplitude of vibration. Note that the criteria for equivalence are equal energy distribution per cycle and the same relative amplitude.

Frequency Response Function and Transfer Function Relationship

The transfer function is a mathematical model defining the input-output relationship of a physical system. Figure 1.16 shows a block diagram of a single input-output system. System response (output) is caused by system excitation (input). The casual relationship is loosely defined as shown in Figure 1.17. Mathematically, the transfer function is defined as the Laplace transform of the output divided by the Laplace transform of the input.

The frequency response function is defined in a similar manner and is related to the transfer function. Mathematically, the frequency response function is defined as the Fourier transform of the output divided by the Fourier transform of the input. These terms are often used interchangeably and are occasionally a source of confusion.

Figure 1.18
S-plane
representation

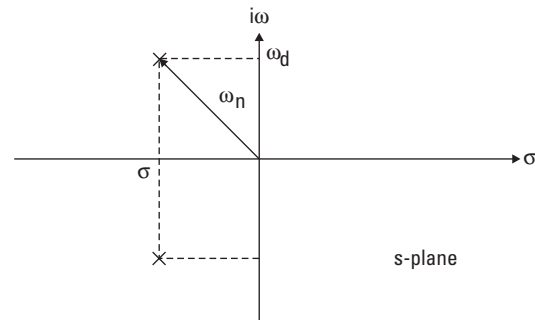

This relationship can be further explained by the modal test process. The measurements taken during a modal test are frequency response function measurements. The parameter estimation routines are, in general, curve fits in the Laplace domain and result in the transfer functions. The curve fit simply infers the location of system poles in the s-plane from the frequency response functions as illustrated in Figure 1.18. The frequency response is simply the transfer function measured along the $j\omega$ axis as illustrated in Figure 1.19.

Figure 1.19
3-D Laplace
representation

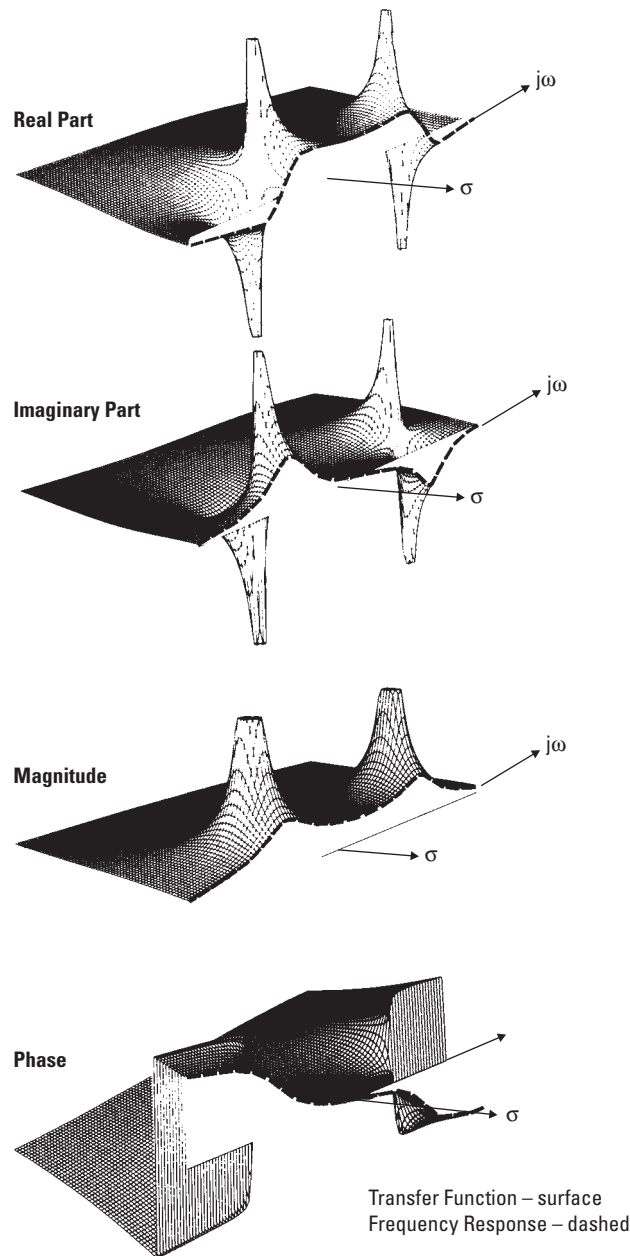

System Assumptions

The structural dynamics background theory and the modal parameter estimation theory are based on two major assumptions:

- The system is linear.
- The system is stationary.

There are, of course, a number of other system assumptions such as observability, stability, and physical realizability. However, these assumptions tend to be addressed in the inherent properties of mechanical systems. As such, they do not present practical limitations when making frequency response measurements as do the assumptions of linearity and stationarity.

Chapter 2

Frequency Response Measurements

Introduction

This chapter investigates the current instrumentation and techniques available for acquiring frequency response measurements. The discussion begins with the use of a dynamic signal analyzer and associated peripherals for making these measurements. The type of modal testing known as the frequency response function method, which measures the input excitation and output response simultaneously, as shown in the block diagram in Figure 2.1, is examined. The focus is on the use of one input force, a technique commonly known as single-point excitation, illustrated in Figure 2.2. By understanding this technique, it is easy to expand to the multiple input technique.

With a dynamic signal analyzer, which is a Fourier transform-based instrument, many types of excitation sources can be implemented to measure a structure's frequency response function. In fact, virtually any physically realizable signal can be input or measured. The selection and implementation of the more common and useful types of signals for modal testing are discussed.

Transducer selection and mounting methods for measuring these signals along with system calibration meth-

Figure 2.1
System block diagram

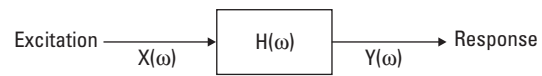
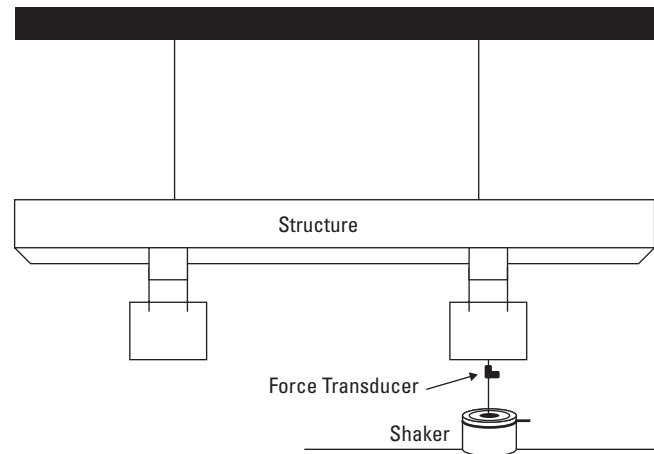

Figure 2.2
Structure under test



ods, are also included. Techniques for improving the quality and accuracy of measurements are then explored. These include processes such as averaging, windowing and zooming, all of which reduce measurement errors. Finally, a section on measurement interpretation is included to aid in understanding the complete measurement process.

General Test System Configurations

The basic test setup required for making frequency response measurements depends on a few major factors. These include the type of structure to be tested and the level of results desired. Other factors, including the support fixture and the excitation mechanism, also affect the amount of hardware needed to perform the test. Figure 2.3 shows a diagram of a basic test system configuration.

The heart of the test system is the controller, or computer, which is the operator's communication link to the analyzer. It can be configured with various levels of memory, displays and data storage. The modal analysis software usually resides here, as well as any additional analysis capabilities such as structural modification and forced response.

The analyzer provides the data acquisition and signal processing operations. It can be configured with several input channels, for force and response measurements, and with one or more excitation sources for driving shakers. Measurement functions such as windowing, averaging and Fast Fourier Transforms (FFT) computation are usually processed within the analyzer.

Figure 2.3
General test configuration

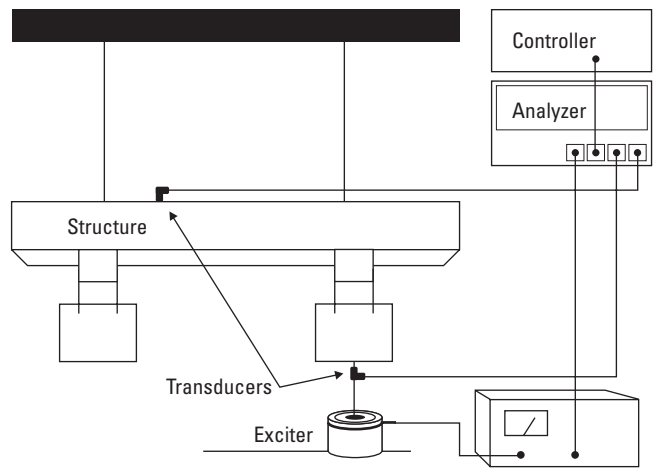

For making measurements on simple structures, the exciter mechanism can be as basic as an instrumented hammer. This mechanism requires a minimum amount of hardware. An electrodynamic shaker may be needed for exciting more complicated structures. This shaker system requires a signal source, a power amplifier and an attachment device. The signal source, as mentioned earlier, may be a component of the analyzer.

Transducers, along with a power supply for signal conditioning, are used to measure the desired force and responses. The piezoelectric types, which measure force and acceleration, are the most widely used for modal testing. The power supply for signal conditioning may be voltage or charge mode and is sometimes provided as a component of the analyzer, so care should be taken in setting up and matching this part of the test system.

Supporting The Structure

The first step in setting up a structure for frequency response measurements is to consider the fixturing mechanism necessary to obtain the desired constraints (boundary conditions). This is a key step in the process as it affects the overall structural characteristics, particularly for subsequent analyses such as structural modification, finite element correlation and substructure coupling.

Analytically, boundary conditions can be specified in a completely free or completely constrained sense. In testing practice, however, it is generally not possible to fully achieve these conditions. The free condition means that the structure is, in effect, floating in space with no attachments to ground and exhibits rigid body behavior at zero frequency. The airplane shown in Figure 2.4a is an example of this free condition. Physically, this is not realizable, so the structure must be supported in some manner. The constrained condition implies that the motion, (displacements/rotations) is set to zero. However, in reality most structures exhibit some degree of flexibility at the grounded connections. The satellite dish in Figure 2.4b is an example of this condition.

In order to approximate the free system, the structure can be suspended from very soft elastic cords or placed on a very soft cushion. By doing this, the structure will be constrained to a degree and the rigid body modes will no longer have zero frequency. However, if a sufficiently soft support

Figure 2.4a
Example of
free support
situation

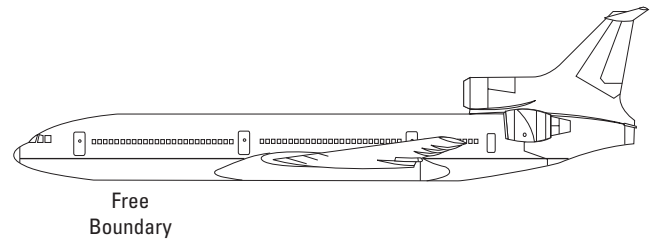
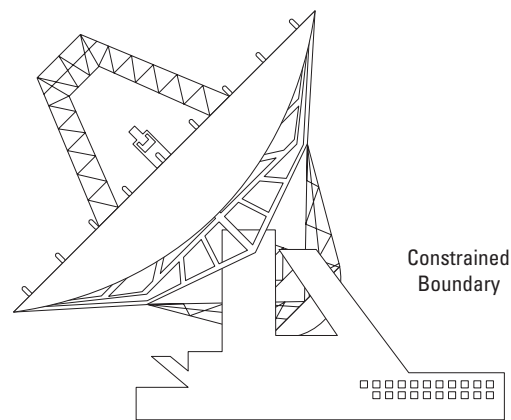

Figure 2.4b
Example of
constrained
support
situation



system is used, the rigid body frequencies will be much lower than the frequencies of the flexible modes and thus have negligible effect. The rule of thumb for free supports is that the highest rigid body mode frequency must be less than one tenth that of the first flexible mode. If this criterion is met, rigid body modes will have negligible effect on flexible modes. Figure 2.5 shows a typical frequency response measurement of this type with nonzero rigid body modes.

The implementation of a constrained system is much more difficult to achieve in a test environment. To begin with, the base to which the structure is attached will tend to have some motion of its own. Therefore, it is not going to be purely grounded. Also, the attachment points will have some degree of flexibility due to the bolted, riveted or welded connections. One possible remedy for these problems is to measure the frequency

response of the base at the attachment points over the frequency range of interest. Then, verify that this response is significantly lower than the corresponding response of the structure, in which case it will have a negligible effect. However, the frequency response may not be measurable, but can still influence the test results.

There is not a best practical or appropriate method for supporting a structure for frequency response testing. Each situation has its own characteristics. From a practical standpoint, it would not be feasible to support a large factory machine weighing several tons in a free test state. On the other hand, there may be no convenient way to ground a very small, lightweight device for the constrained test state. A situation could occur, with a satellite for example, where the results of both tests are desired. The free test is required to analyze the satellite's operating environment in space. However, the constrained test is also needed to assess the launch environment attached to the boost vehicle. Another reason for choosing the appropriate boundary conditions is for finite element model correlation or substructure coupling analyses. At any rate, it is certainly important during this phase of the test to ascertain all the conditions in which the results may be used.

Figure 2.5
Frequency response of freely suspended system

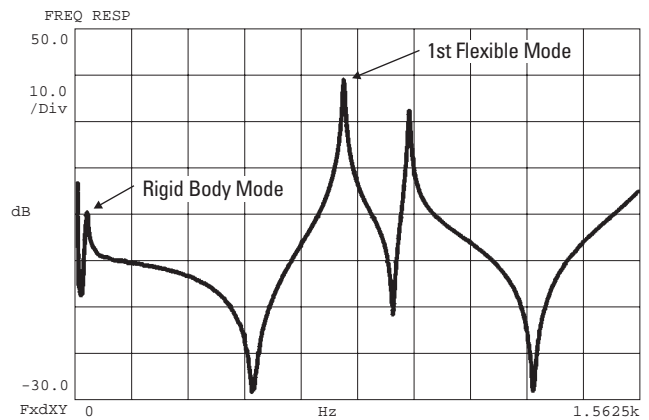

Exciting the Structure

The next step in the measurement process involves selecting an excitation function (e.g., random noise) along with an excitation system (e.g., a shaker) that best suits the application. The choice of excitation can make the difference between a good measurement and a poor one. Excitation selection should be approached from both the type of function desired and the type of excitation system available because they are interrelated. The excitation function is the mathematical signal used for the input. The excitation system is the physical mechanism used to provide the signal. Generally, the choice of the excitation function dictates the choice of the excitation system, a true random or burst

random function requires a shaker system for implementation. In general, the reverse is also true. Choosing a hammer for the excitation system dictates an impulsive type excitation function.

Excitation functions fall into four general categories: steady-state, random, periodic and transient. There are several papers that go into great detail examining the applications of the most common excitation functions. Table 2.1 summarizes the basic characteristics of the ones that are most useful for modal testing. True random, burst random and impulse types are considered in the context of this note since they are the most widely implemented. The best choice of excitation function depends on several factors: available signal

processing equipment, characteristics of the structure, general measurement considerations and, of course, the excitation system.

A full function dynamic signal analyzer will have a signal source with a sufficient number of functions for exciting the structure. With lower quality analyzers, it may be necessary to obtain a signal source as a separate part of the signal processing equipment. These sources often provide fixed sine and true random functions as signals; however, these may not be acceptable in applications where high levels of accuracy are desired. The types of functions available have a significant influence on measurement quality.

Table 2.1
Excitation functions

	Sine steady state	True random	Periodic* in analyzer window			Transient in analyzer window		
			Pseudo random	Random	Fast sine	Impact	Burst sine	Burst random
Minimize leakage	No	No	Yes	Yes	Yes	Yes	Yes	Yes
Signal to noise	Very high	Fair	Fair	Fair	High	Low	High	Fair
RMS to peak ratio	High	Fair	Fair	Fair	High	Low	High	Fair
Test measurement time	Very long	Good	Very good	Fair	Fair	Very good	Very good	Very good
Controlled frequency content	Yes	Yes*	Yes*	Yes*	Yes*	No	Yes*	Yes*
Controlled amplitude content	Yes	No	Yes*	No	Yes*	No	Yes*	No
Removes distortion	No	Yes	No	Yes	No	No	No	Yes
Characterize nonlinearity	Yes	No	No	No	Yes	No	Yes	No

* Requires additional equipment or special hardware

The dynamics of the structure are also important in choosing the excitation function. The level of nonlinearities can be measured and characterized effectively with sine sweeps or chirps, but a random function may be needed to estimate the best linearized model of a nonlinear system. The amount of damping and the density of the modes within the structure can also dictate the use of specific excitation functions. If modes are closely coupled and/or lightly damped, an excitation function that can be implemented in a leakage-free manner (burst random for example) is usually the most appropriate.

Excitation mechanisms fall into four categories: shaker, impactor, step relaxation and self-operating. Step relaxation involves preloading the structure with a measured force through a cable then releasing the

cable and measuring the transients. Self-operating involves exciting the structure through an actual operating load. This input cannot be measured in many cases, thus limiting its usefulness. Shakers and impactors are the most common and are discussed in more detail in the following sections. Another method of excitation mechanism classification is to divide them into attached and nonattached devices. A shaker is an attached device, while an impactor is not, (although it does make contact for a short period of time).

Shaker Testing

The most useful shakers for modal testing are the electromagnetic shown in Fig. 2.6 (often called electrodynamic) and the electrohydraulic (or, hydraulic) types. With the electromagnetic shaker, (the more common of the two), force is generated by an alternating current that drives a magnetic coil. The maximum frequency limit varies from approximately 5 kHz to 20 kHz depending on the size; the smaller shakers having the higher operating range. The maximum force rating is also a function of the size of the shaker and varies from approximately 2 lbf to 1000 lbf; the smaller the shaker, the lower the force rating.

With hydraulic shakers, force is generated through the use of hydraulics, which can provide much higher force levels – some up to several thousand pounds. The maximum frequency range is much lower though – about 1 kHz and below. An advantage of the hydraulic shaker is its ability to apply a large static preload to the structure. This is useful for massive structures such as grinding machines that operate under relatively high preloads which may alter their structural characteristics.

There are several potential problem areas to consider when using a shaker system for excitation. To begin with, the shaker is physically mounted to the structure via the force transducer, thus creating the possibility of altering the dynamics of the structure. With lightweight structures, the mechanism used to mount the load cell may add appreciable mass to the structure. This causes the force measured by the load cell to be greater than the force actually applied to the structure. Figure 2.7 describes how this mass loading alters the input force. Since the extra mass is between the load cell and the structure the load cell senses this extra mass as part of the structure.

Since the frequency response is a single input function, the shaker should transmit only one component of force in line with the main axis of the load cell. In practical situations, when a structure is displaced along a linear axis it also tends to rotate about the other two axes. To minimize the problem of forces being applied in other directions, the shaker should be connected to the load cell through a slender rod, called a stinger, to allow the structure to move freely in the other directions. This rod, shown in Figure 2.8, has a strong axial stiffness, but weak bending and shear stiffnesses. In effect, it acts like a truss member, carrying only axial loads but no moments or shear loads.

Figure 2.6
Electrodynamic shaker with power amplifier and signal source

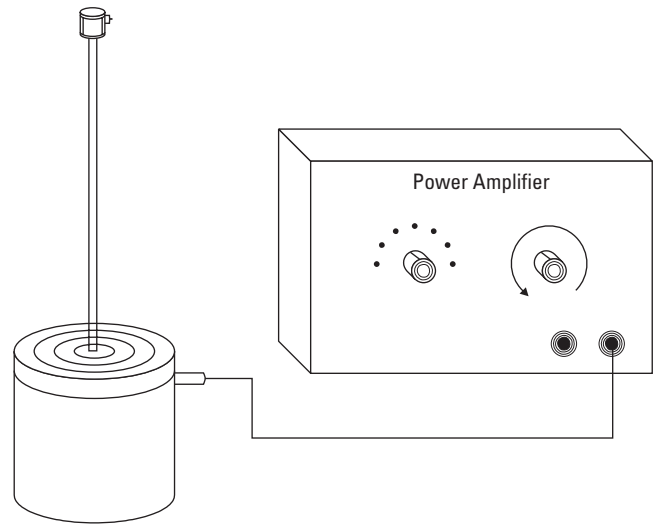
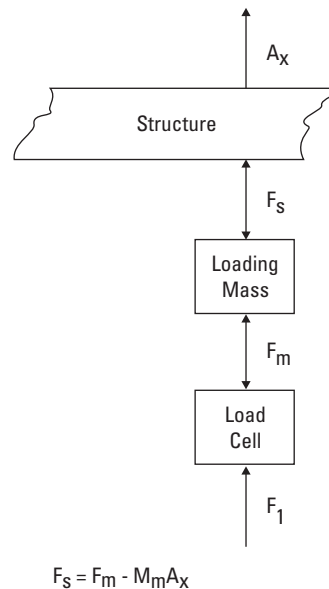

Figure 2.7
Mass loading from shaker setup



The method of supporting the shaker is another factor that can affect the force imparted to the structure. The main body of the shaker must be isolated from the structure to prevent any reaction forces from being transmitted through the base of the shaker back to the structure. This can be accomplished by mounting the shaker on a solid floor and suspending the structure from above. The shaker could also be supported on a mechanically isolated foundation. Another method is to suspend the shaker, in which case an inertial mass usually needs to be attached to the shaker body in order to generate a measurable force, particularly at lower frequencies. Figure 2.9 illustrates the different types of shaker setups.

Another potential problem associated with electromagnetic shakers is the impedance mismatch that can exist between the structure and the shaker coil. The electrical impedance of the shaker varies with the amplitude of motion of the coil. At a resonance with a small effective mass, very little force is required to produce a response. This can result in a drop in the force spectrum in the vicinity of the resonance, causing the force measurement to be susceptible to noise. Figure 2.10 illustrates an example of this phenomenon. The problem can usually be corrected by using shakers with different size coils or driving the shaker with a constant-current type amplifier. The shaker could also be moved to a point with a larger effective mass.

Figure 2.8
Stinger attachment to structure

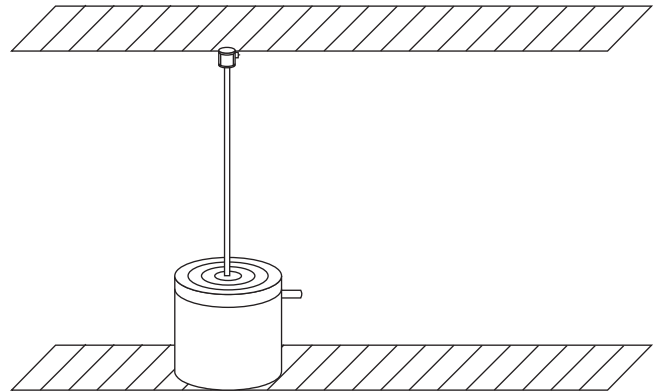

Figure 2.9
Test support mechanisms

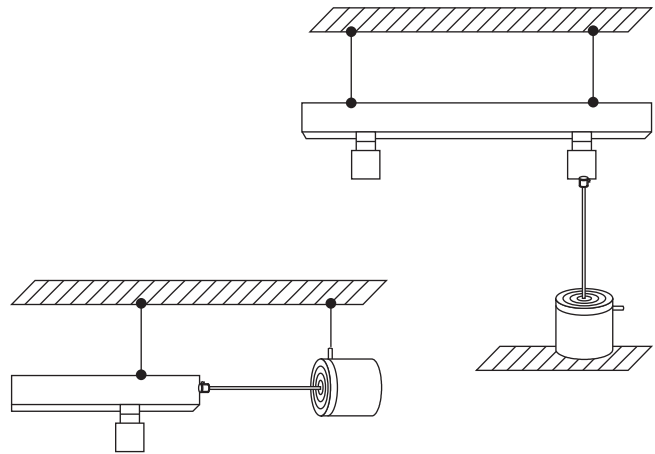
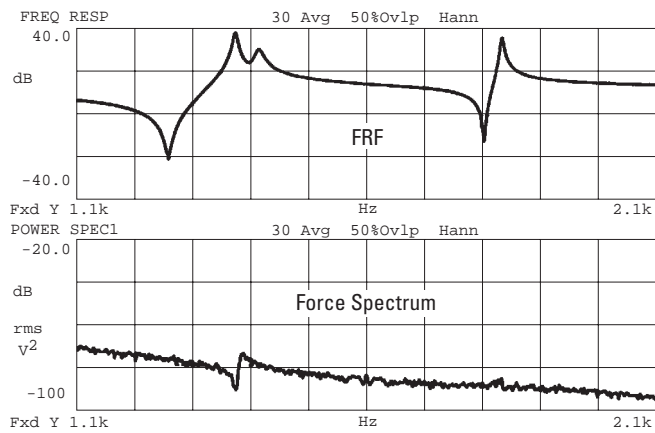

Figure 2.10
Shaker/structure impedance mismatch



Impact Testing

Another common excitation mechanism in modal testing is an impact device. Although it is a relatively simple technique to implement, it's difficult to obtain consistent results. The convenience of this technique is attractive because it requires very little hardware and provides shorter measurement times. The method of applying the impulse, shown in Figure 2.11, includes a hammer, an electric gun or a suspended mass. The hammer, the most common of these, is used in the following discussion. However, this information also applies to the other types of impact devices.

Since the force is an impulse, the amplitude level of the energy applied to the structure is a function of the mass and the velocity of the hammer. This is due to the concept of linear momentum, which is defined as mass times velocity. The linear impulse is equal to the incremental change in the linear momentum. It is difficult though to control the velocity of the hammer, so the force level is usually controlled by varying the mass. Impact hammers are available in weights varying from a few ounces to several pounds. Also, mass can be added to or removed from most hammers, making them useful for testing objects of varying sizes and weights.

The frequency content of the energy applied to the structure is a function of the stiffness of the contacting surfaces and, to a lesser extent, the mass of the hammer. The stiffness of the contacting surfaces affects the shape of the force pulse, which in turn determines the frequency content.

Figure 2.11
Impact devices
for testing

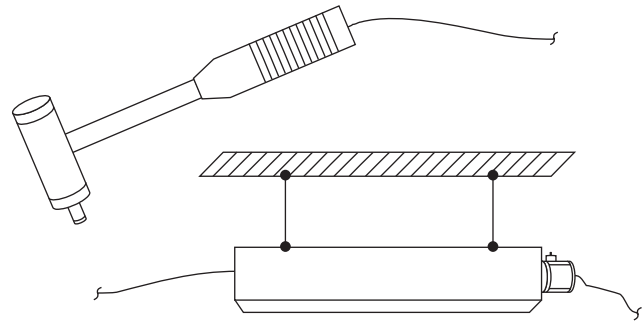
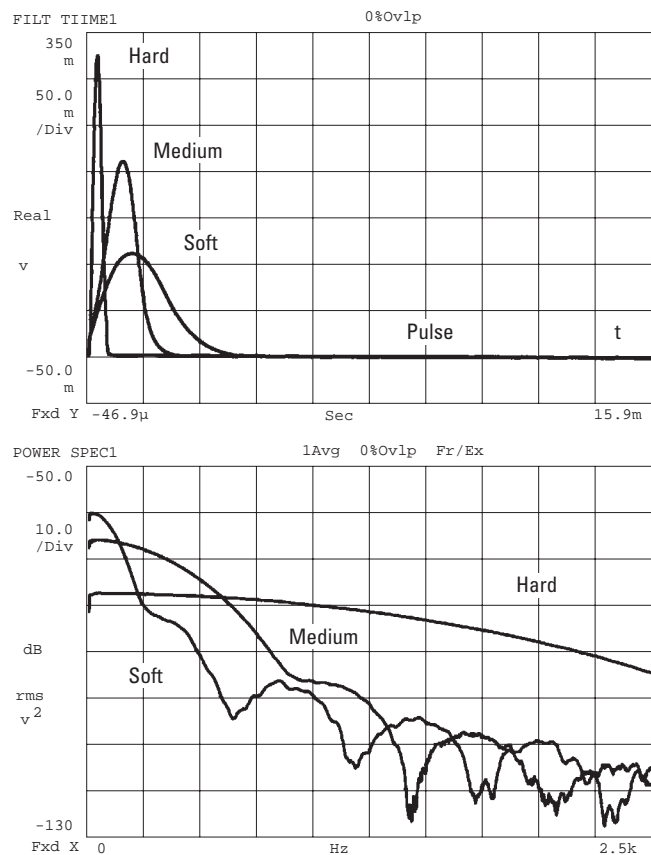
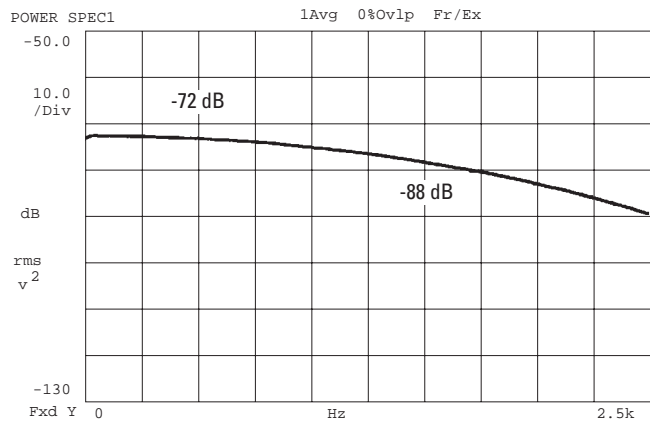

Figure 2.12
Frequency
content of
various pulses



It is not feasible to change the stiffness of the test object, therefore the frequency content is controlled by varying the stiffness of the hammer tip. The harder the tip, the shorter the pulse duration and thus the higher the frequency content. Figure 2.12 illustrates this effect on the force spectrum. The rule of thumb is to choose a tip so that the amplitude of the force spectrum is no more than 10 dB to 20 dB down at the maximum frequency of interest as shown in Figure 2.13. A disadvantage to note here is that the force spectrum of an impact excitation cannot be band-limited at lower frequencies when making zoom measurements, so the lower out-of-band modes will still be excited.

Figure 2.13
Useful frequency range of pulse spectrum



Impact testing has two potential signal processing problems associated with it. The first – noise – can be present in either the force or response signal as a result of a long time record. The second – leakage – can be present in the response signal as a result of a short time record. Compensation for both these problems can be accomplished with windowing techniques.

Figure 2.14
Force pulse with force window applied

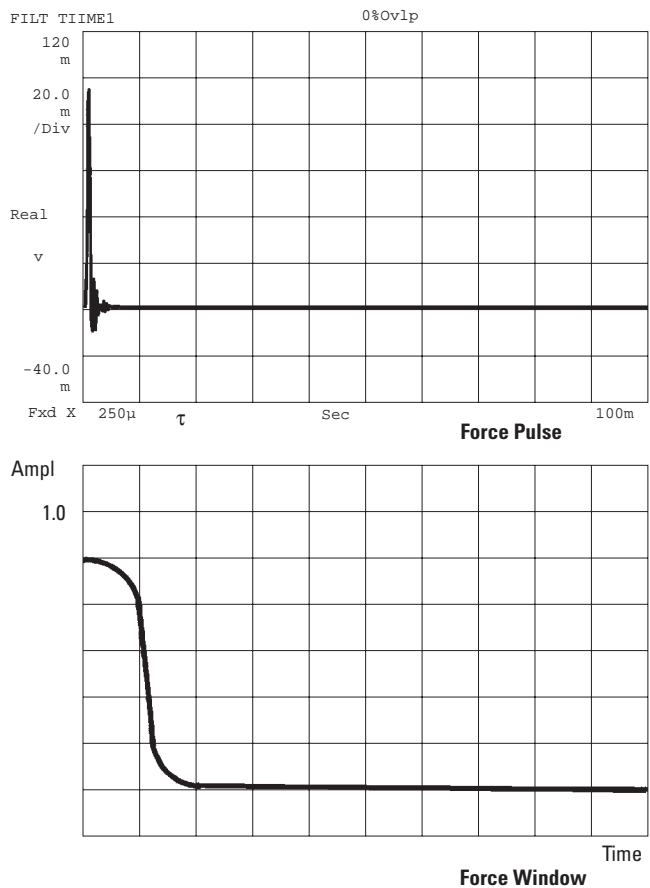

Since the force pulse is usually very short relative to the length of the time record, the portion of the signal after the pulse is noise and can be eliminated without affecting the pulse itself. The window designed to accomplish this, called a force window, is shown in Figure 2.14. The small amount of oscillation that occurs at the end of the pulse is actually part of the pulse. It is a result of signal processing and should not be truncated.

The response signal is an exponential decaying function and may decay out before or after the end of the measurement. If the structure is heavily damped, the response may decay out before the end of the time record. In this case, the response window can be used to eliminate the remaining noise in the time record. If the structure is lightly damped, the response may continue beyond the end of the time record. In this case, it must be artificially forced to decay out to minimize leakage. The window designed to accomplish either result, called the exponential window, is shown in Figure 2.15. The rule of thumb for setting the time constant, (the time required for the amplitude to be reduced by a factor of $1/e$), is about one-fourth the time record length, T . The result of this is shown in Figure 2.15.

Unlike the force window, the exponential window can alter the resulting frequency response because it has the effect of adding artificial damping to the system. The added damping coefficient can usually be backed out of the measurement after signal processing, but numerical problems may arise with lightly damped structures. This can happen when the added damping from the exponential window is significantly more than the true damping in the structure. A better measurement procedure in this case would be to zoom, thus utilizing a longer time record in order to capture the entire response, instead of relying on the exponential window.

Figure 2.15
Decaying response with exponential window applied

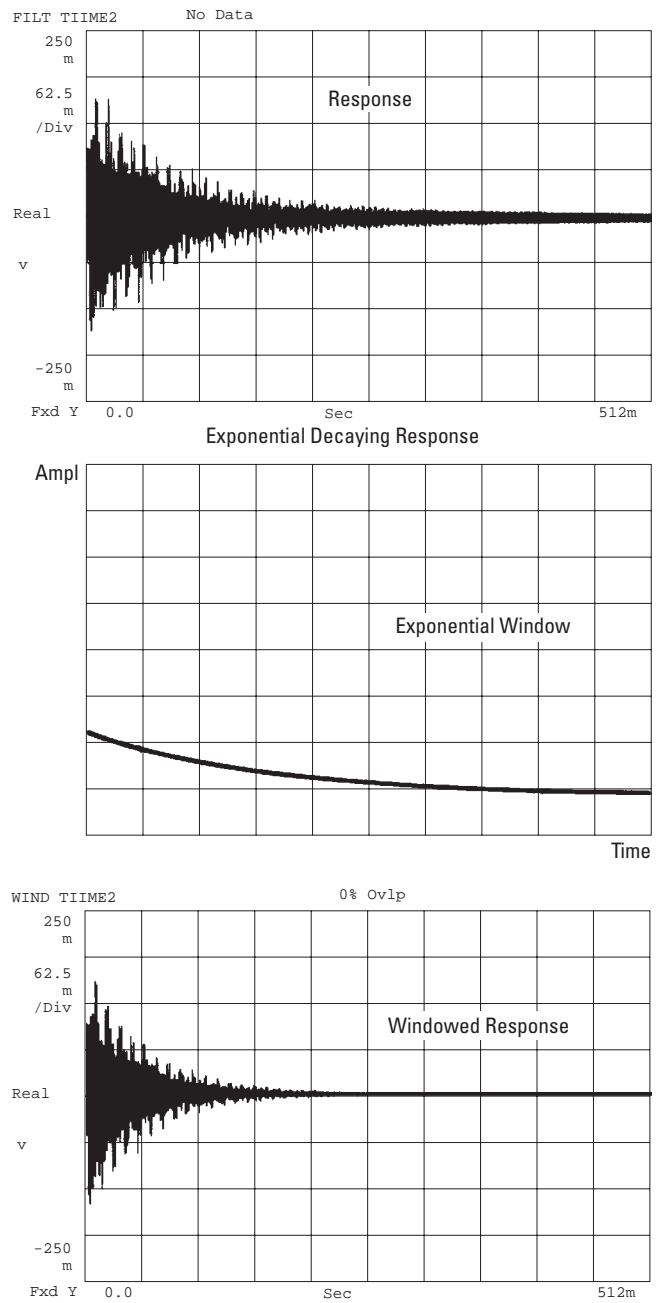

Transduction

Now that an excitation system has been set up to force the structure into motion, the transducers for sensing force and motion need to be selected. Although there are various types of transducers, the piezoelectric type is the most widely used for modal testing. It has wide frequency and dynamic ranges, good linearity and is relatively durable. The piezoelectric transducer is an electromechanical sensor that generates an electrical output when subjected to vibration. This is accomplished with a crystal element that creates an electrical charge when mechanically strained.

The mechanism of the force transducer, called a load cell, functions in a fairly simple manner. When the crystal element is strained, either by tension or compression, it generates a charge proportional to the applied force. In this case, the applied force is from the shaker. However, due to mounting methods discussed earlier, this is not necessarily the force transmitted to the structure.

The mechanism of the response transducer, called an accelerometer, functions in a similar manner. When the accelerometer vibrates, an internal mass in the assembly applies a force to the crystal element which is proportional to the acceleration. This relationship is simply Newton's Law: force equals mass times acceleration.

The properties to consider in selecting a load cell include both the type of force sensor and its performance characteristics. The type of force sensing for which load cells are designed include compression, tension, impact or some combination

Figure 2.16
Frequency response of transducer

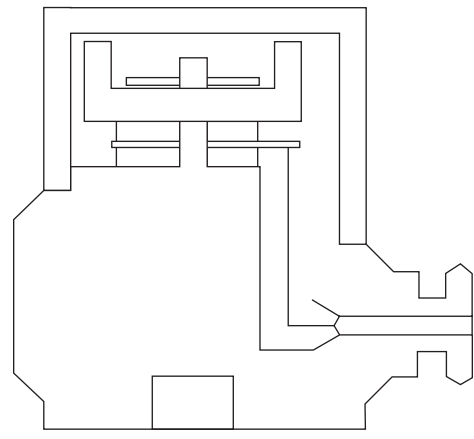

Response Transducer (Accelerometer)

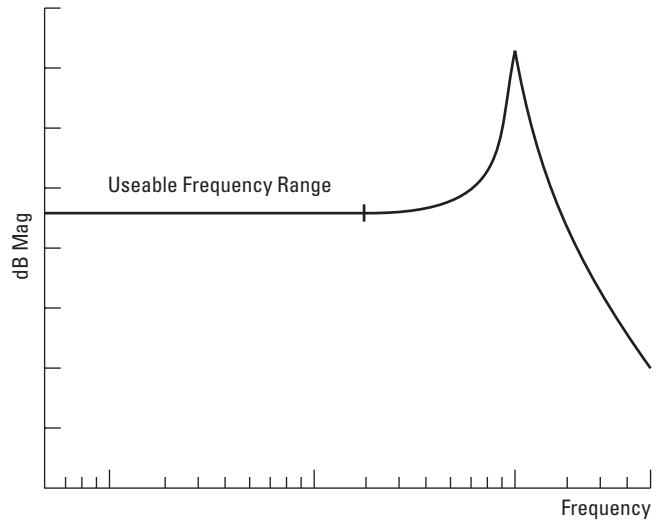
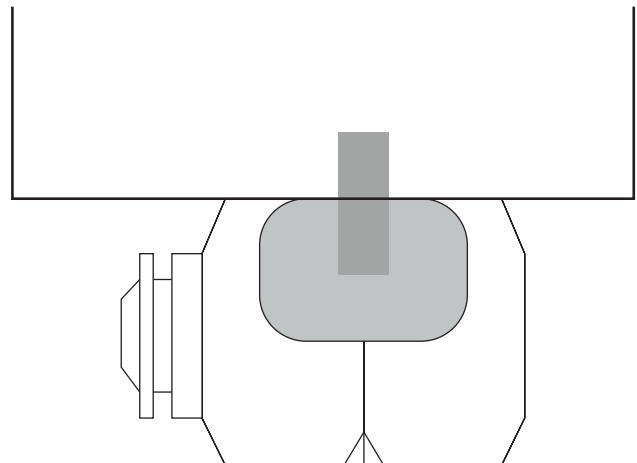

Figure 2.17
Stud mounted load cell



thereof. Most shaker tests require at least a compression and tension type. A hammer test, for example, would require an impact transducer.

Some of the operating specifications to consider are sensitivity, resonant frequency, temperature range and shock rating. Sensitivity is measured in terms of voltage/force with units of mV/lb or mV/N. Analyzers have a range of input voltage settings; therefore, sensitivity should be chosen along with a power supply amplification level to generate a measurable voltage.

The resonant frequency of a load cell is simply a function of its physical mass and stiffness characteristics. The frequency range of the test should fall within the linear range below the resonant peak of the frequency response of the load cell, as shown in Figure 2.16. The rule of thumb for shock rating is that the maximum vibration level expected during the test should not exceed one third the shock rating.

The load cell should be mounted to the structure with a threaded stud for best results as shown in Figure 2.17. If this is not feasible, then an alternative method of first fixing a spacer to the structure with some type of adhesive (such as dental cement) and then stud mounting the load cell to this spacer will usually suffice for low force levels.

The properties to consider in selecting an accelerometer are very similar to those of the load cell, although they are related to acceleration rather than force. The type of response is limited to acceleration as the term implies, since displacement and velocity transducers are not available

Figure 2.18
Frequency response of transducer

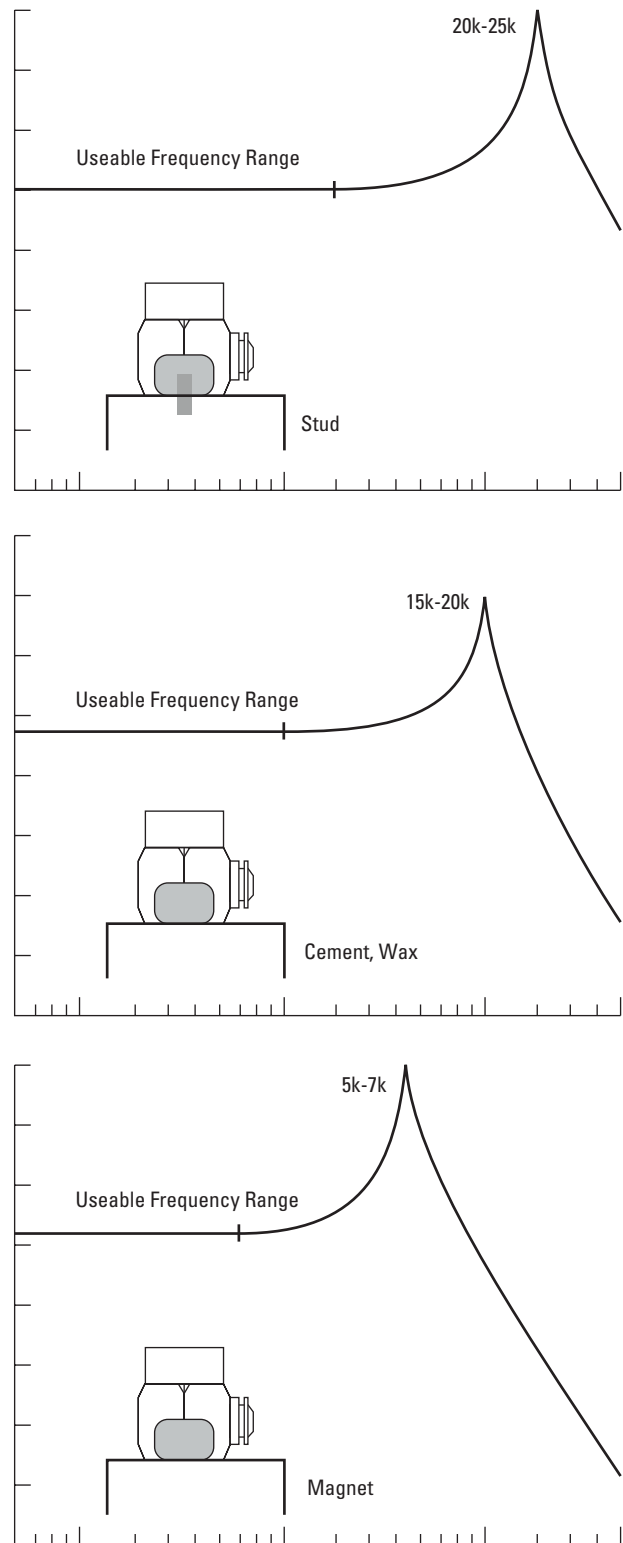
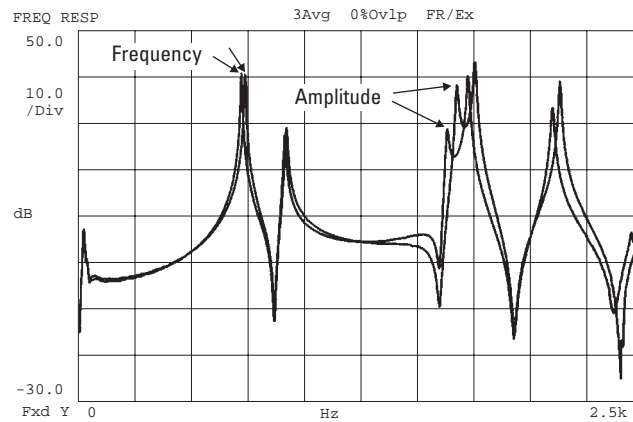

Figure 2.19
Mass loading
from
accelerometer



in the piezoelectric type. However, if displacement or velocity responses are desired, the acceleration response can be artificially integrated once or twice to give velocity and displacement responses, respectively.

In general, the optimum accelerometer has high sensitivity, wide frequency range and small mass. Trade-offs are usually made since high sensitivity usually dictates a larger mass for all but the most expensive accelerometers. The sensitivity, measured in mV/G, and the shock rating should be selected in the same manner as with the load cell.

Although the resonant frequency of the accelerometer (freely suspended) is a function of its mass and stiffness characteristics, the actual natural frequency (when mounted) is generally dictated by the stiffness of the mounting method used. The effect of various mounting methods is shown in Figure 2.18. The rule of thumb is to set the maximum frequency of the test at no more than one-tenth the mounted natural frequency of the accelerometer. This is within the linear range of the mounted frequency response of the accelerometer.

Another important consideration is the effect of mass loading from the accelerometer. This occurs as a result of the mass of the accelerometer being a significant fraction of the effective mass of a particular mode. A simple procedure to determine if this loading is significant can be done as follows:

- Measure a typical frequency response function of the test object using the desired accelerometer.
- Mount another accelerometer (in addition to the first) with the same mass at the same point and repeat the measurement.
- Compare the two measurements and look for frequency shifts and amplitude changes.

If the two measurements differ significantly, as illustrated in Figure 2.19, then mass loading is a problem and an accelerometer with less mass should be used. On very small structures, it may be necessary to measure the response with a non-contacting transducer, such as an acoustical or optical sensor, in order to eliminate any mass loading.

Figure 2.20
Example of
the input
half ranging

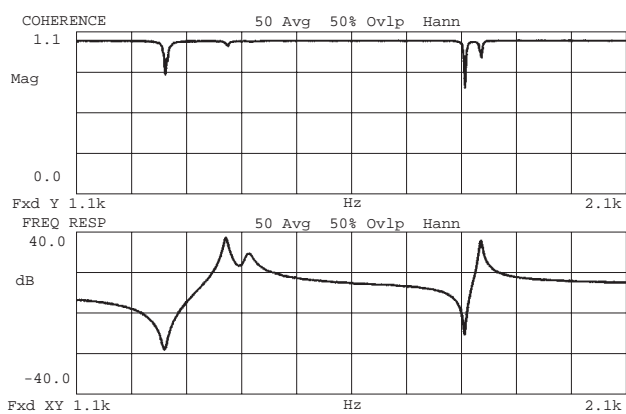
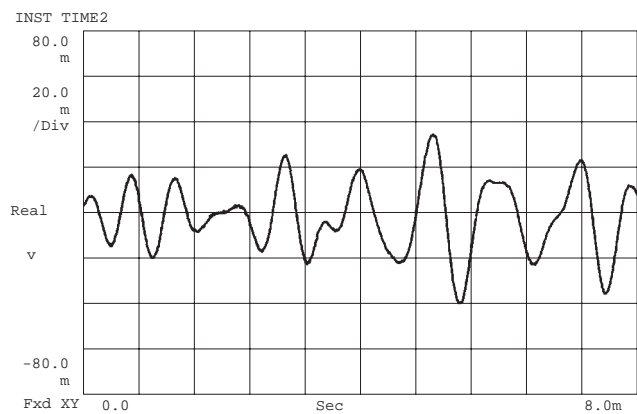

Figure 2.21
Example of
the input
under ranging

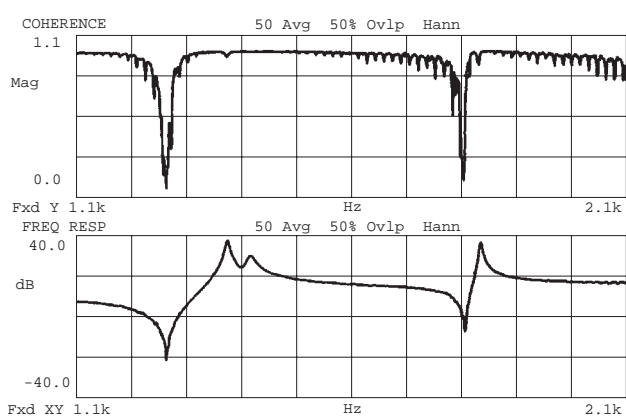
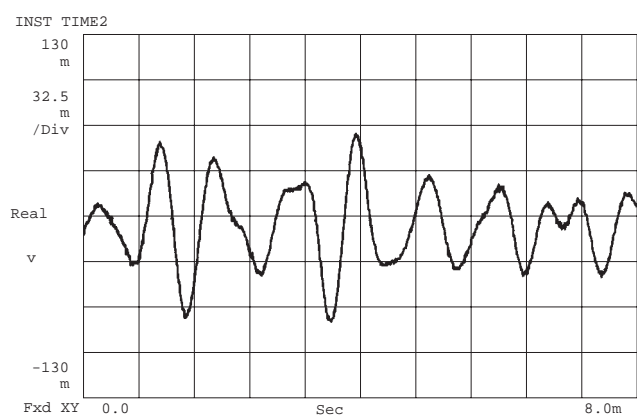
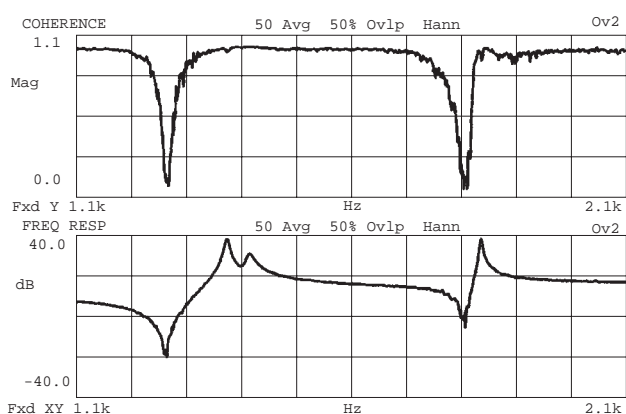
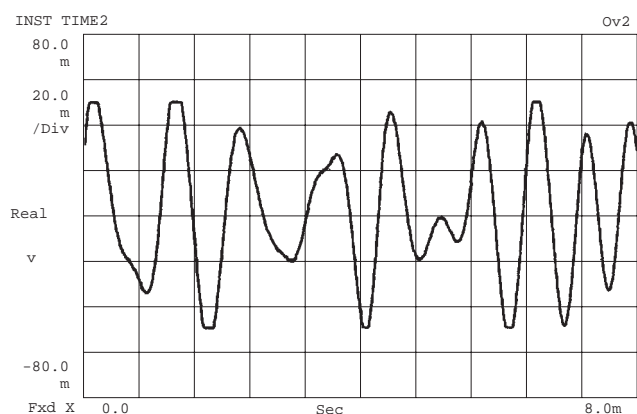

Figure 2.22
Example of
the input
over ranging



Measurement Interpretation

Having discussed the mechanics of setting up a modal test, it is appropriate at this point to make some trial measurements and examine their trends before proceeding with data collection. Taking the time to investigate preliminaries of the test, such as exciter or response locations, various types of excitation functions and different signal processing parameters will lead to higher quality measurements. This section includes preliminary checks such as adequate signal levels, minimum leakage measurements and linearity and reciprocity checks. The concept and trends of the driving point measurement and the combinations of measurements that constitute a complete modal survey are discussed.

After the structure has been supported and instrumented for the test, the time domain signals should be examined before making measurements. The input range settings on the analyzer should be set at no more than two times the maximum signal level as shown in Figure 2.20. Often called half-ranging, this takes advantage of the dynamic range of the analog-to-digital converter without underranging or overranging the signals.

The effect resulting from under-ranging a signal, where the response input level is severely low relative to the analyzer setting, is illustrated in Figure 2.21. Notice the apparent noise between the peaks in the frequency response and the resulting poor coherence function. In Figure 2.22, the response is severely overloading the analyzer input section and is being clipped. This results in poor frequency response and, consequently, poor coherence since the actual response is not being measured correctly.

Figure 2.23
Random test signals

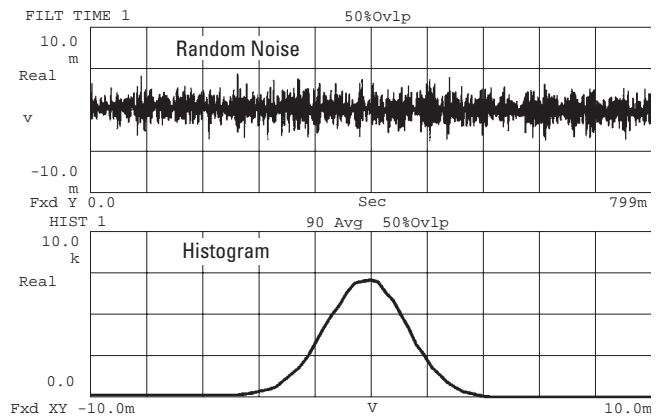
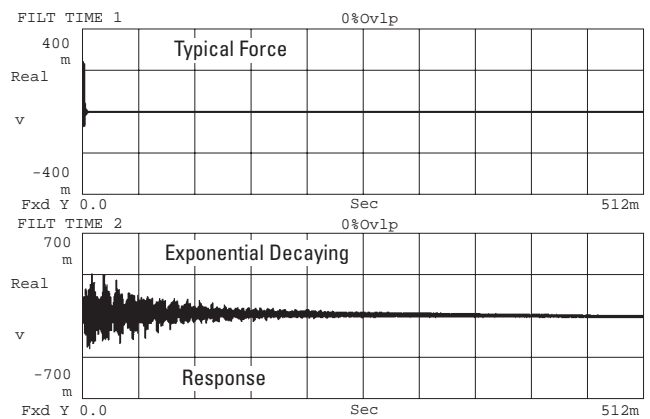

Figure 2.24
Transient test signals



It is also advisable to verify that the signals are indeed the type expected, (e.g., random noise). With a random signal, it is advisable to measure the histogram to verify that it is not contaminated with other signal components, i.e., it has a Gaussian distribution as shown in Figure 2.23. This can be visually checked as illustrated with the transient signals in Figure 2.24.

Chapter 3

Improving Measurement Accuracy

Measurement Averaging

In order to reduce the statistical variance of a measurement with a random excitation function (such as random noise) and also reduce the effects of nonlinearities, it is necessary to employ an averaging process. By averaging several time records together, statistical reliability can be increased and random noise associated with nonlinearities can be reduced. One method to gain insight into the variance of a measurement is to observe the Nyquist display of

the frequency response. The circle appears very distorted for a measurement with few averages, but begins to smooth out with more and more averages. This process can be seen in Figure 3.1. With each data record acquired, the frequency spectrum has a different magnitude and phase distribution. As these spectra are averaged, the nonlinear terms tend to cancel, thus resulting in the best linear estimate.

Figure 3.1
Measurement averaging frequency response

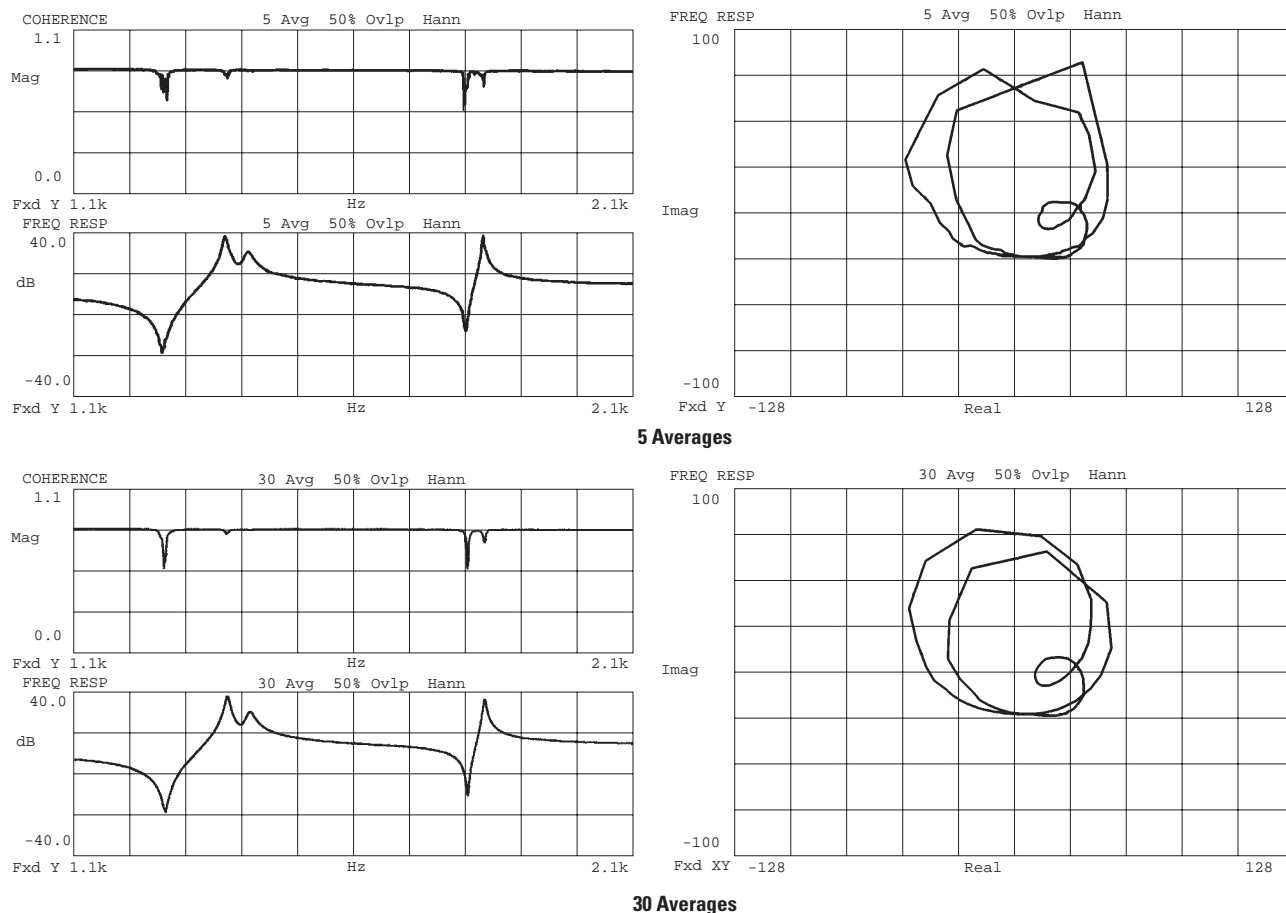

Windowing Time Data

There is a property of the Fast Fourier transform (FFT) that affects the energy distribution in the frequency spectrum. It is the result of the physical limitation of measuring a finite length time record along with the periodicity assumption required of the time record by the FFT. This does not present a problem when the signal is exactly periodic in the time record or when a transient signal is completely captured within the time record. However, in the case of true random excitation or in the transient case when the entire response is not captured, a phenomenon called leakage results. This has the effect of smearing or leaking energy into adjacent frequency lines of the spectrum, thus distorting it. Figure 3.2 illustrates an example of the effects of severe leakage problems with true random excitation. The effect is to underestimate the amplitude and overestimate the damping factor.

One of the most common techniques for reducing the effects of leakage with a non-periodic signal is to artificially force the signal to 0 at the beginning and end of the time record to make it appear periodic to the analyzer. This is accomplished by multiplying the time record by a mathematical curve, known as a window function, before processing the FFT. Another measurement is taken with a Hann window applied to the true random excitation signal, shown in Figure 3.3. This measurement is more accurate, but notice that the coherence is still less than unity at the resonance. The window does not

Figure 3.2
Frequency response with true random signal and no windows

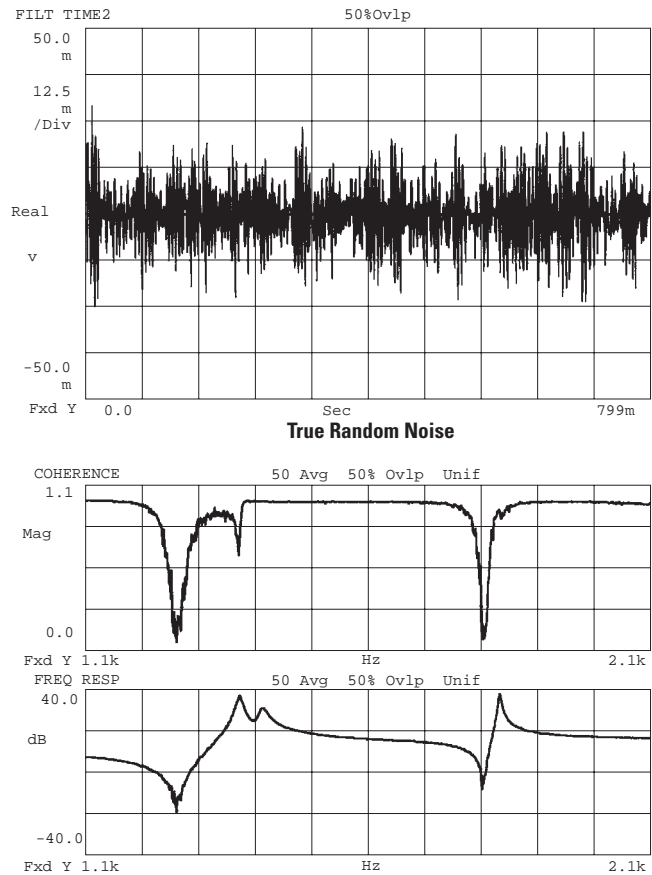
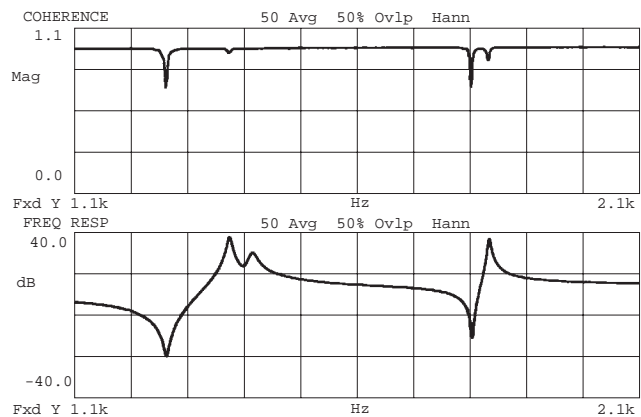

Figure 3.3
Frequency response with burst random signal



eliminate leakage completely and it also distorts the measurement as a result of eliminating some data. A better measurement technique is to use an excitation that is periodic within the time record such as burst random, in order to eliminate the leakage problem as illustrated in Figure 3.4.

Increasing Measurement Resolution

Another measurement capability that is often needed, particularly for lightly damped structures, is to obtain more frequency resolution in the vicinity of resonance peaks. It may not be possible in a baseband measurement to extract valid modal parameters with inadequate information. Normally, the Fourier transform is calculated over a frequency range from 0 to some maximum frequency. Zoom processing is a technique in which the lower and upper frequency limits are independently selectable over fixed ranges within the analyzer. The capability to zoom allows closely spaced modes to be more accurately identified by concentrating the measurement points over a narrower band. The result of this increased measurement accuracy is shown in Figure 3.5. Another result is that distortion due to leakage is reduced, because the smearing of energy is now within a narrower bandwidth, but not eliminated. Another related process associated with zooming is the ability to band-limit the excitation to concentrate the available energy within the given frequency range of the test.

Figure 3.4
Frequency response with true random signal and Hann window

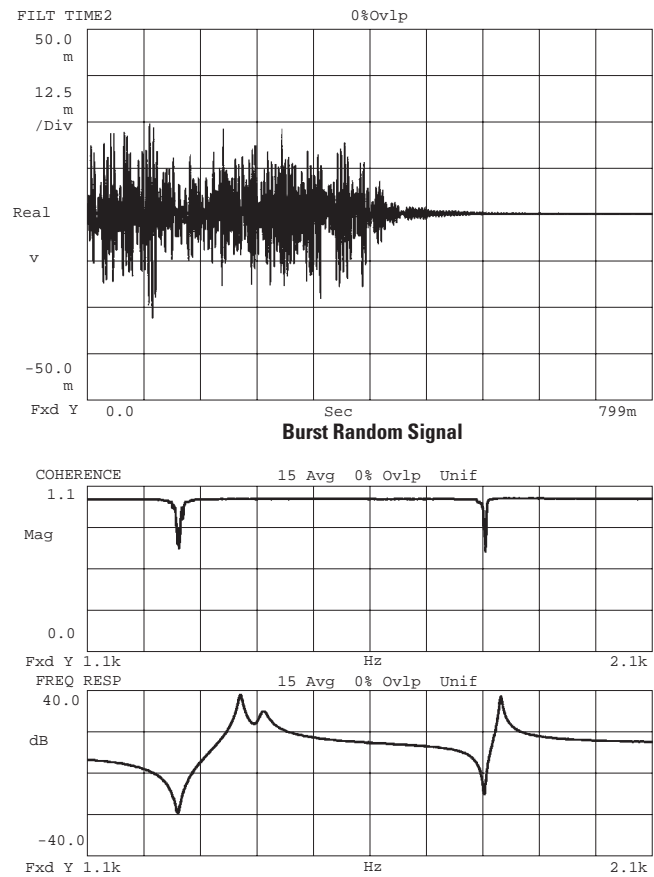
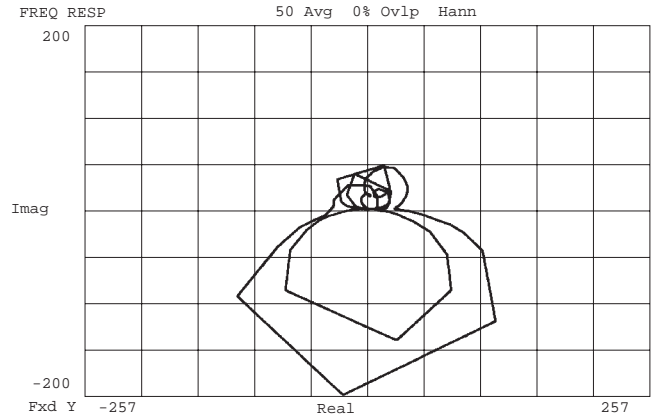
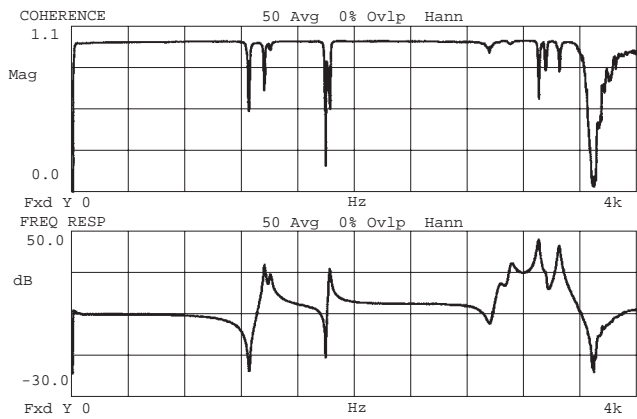
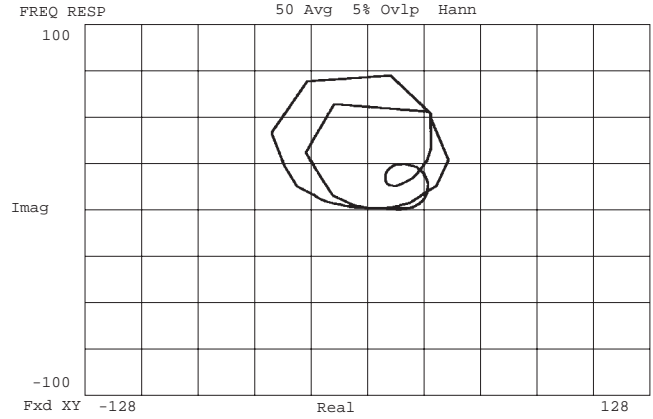
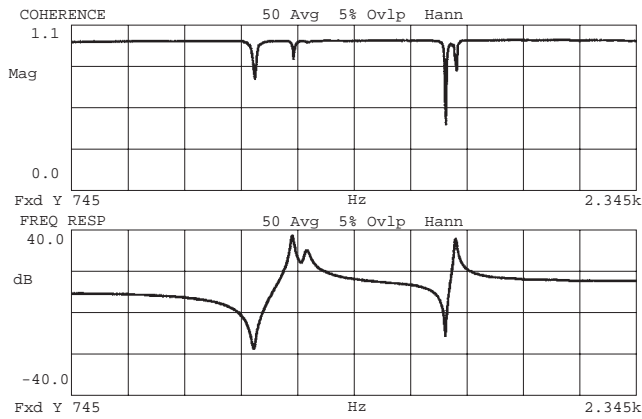

Figure 3.5
Effects of
increasing
frequency
resolution



Baseband Measurement



1st Zoom Span

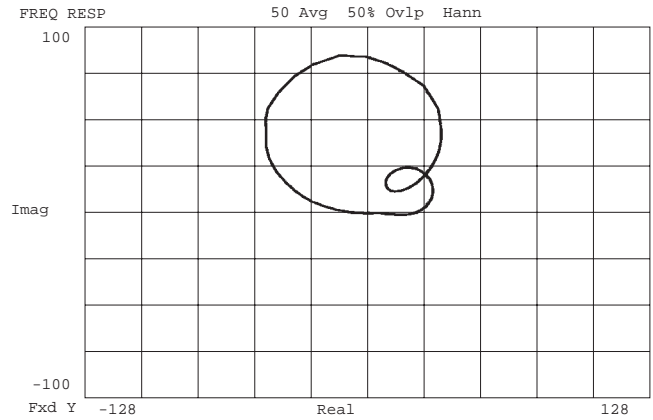
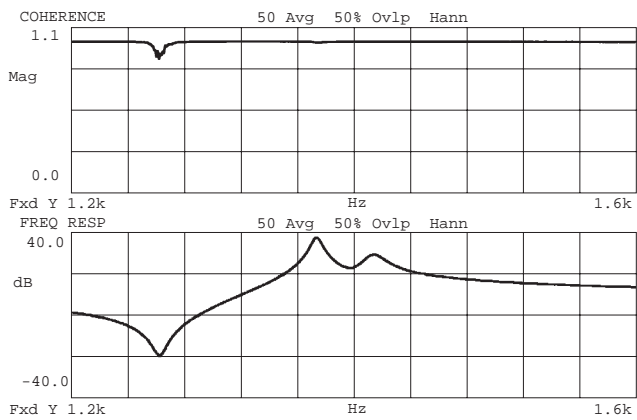

2nd Zoom Span

Complete Survey

As frequency response functions are being acquired and stored for subsequent modal parameter estimation, an adequate set of measurements must be collected in order to arrive at a complete set of modal parameters. This section describes the number and type of measurements that constitute complete modal survey. Definitions and concepts, such as driving point measurement and a row or column of the frequency response matrix are discussed. Optimal shaker and accelerometer locations are also included.

A complete, although redundant, set of frequency response measurements would form a square matrix of size N , where the row corresponds to response points and the columns correspond to excitation points, as illustrated in Figure 3.6. It can be shown, however, that any particular row or column contains sufficient information to compute the complete set of frequencies, damping, and mode shapes. In other words, if the excitation is at point 3, and the response is measured at all the points, including point 3, then column of the frequency response matrix will be measured. This situation would be the result of a shaker test. On the other hand, if an accelerometer is attached to point 7, and a hammer is used to excite the structure at all points, including point 7, then row 7 on the matrix will be measured. This would be the result of an impact test.

The measurement where the response point and direction are the same as the excitation point and direction is called a driving point measurement. The beam in Figure 3.7 illustrates a measurement of this type. Driving point measurements

Figure 3.6
Frequency response matrix

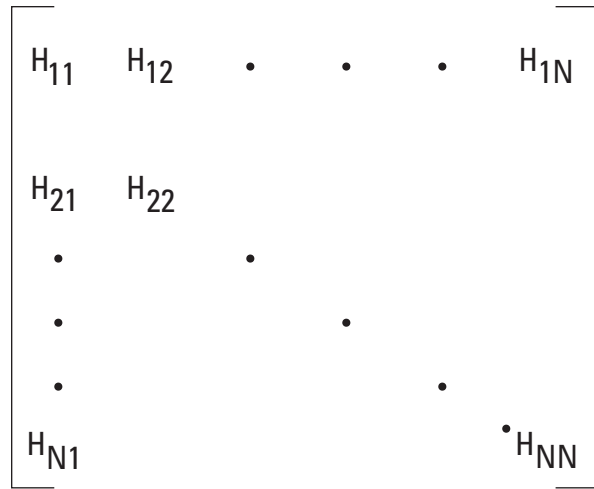
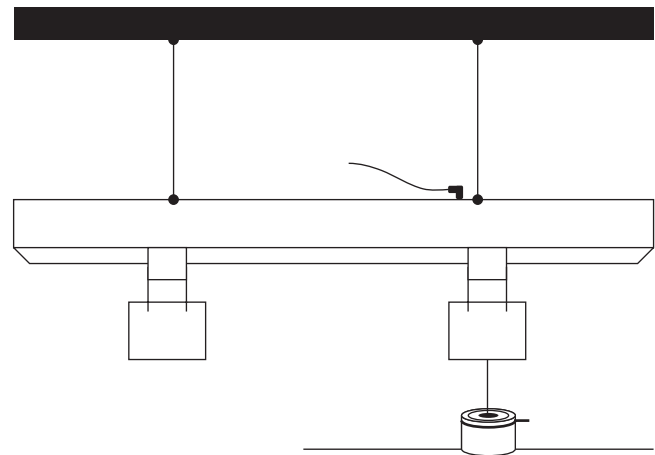

Figure 3.7
Driving point measurement setup



form the diagonal of the frequency response matrix shown above. They also exhibit unique characteristics that are not only useful for checking measurement quality, but necessary for accomplishing a comprehensive modal analysis, which includes not only frequencies, damping factors and scaled mode shapes, but modal mass

and stiffness as well. It is not necessary to make a driving point measurement to obtain only frequencies, damping factors and unscaled mode shapes. However, a set of scaled mode shapes and consequently, modal mass and stiffness cannot be extracted from a set of measurements that does not contain a driving point.

Recall from Chapter 1, Structural Dynamics Background, that the response of a MDOF system is simply the weighted sum of a number of SDOF systems. The characteristics of the driving point measurement can be easily explained and presented as a consequence of this property. Figure 3.8 shows a typical driving point measurement displayed in rectangular and polar coordinates. As seen in the imaginary part of the rectangular coordinates, all of the resonant peaks lie in the same direction. In other words, they are in phase with each other. This characteristic becomes more intuitive when illustrated with the beam modes in Figure 3.9. The response point moves in the same direction as the excitation point at all the modes, since it is measured at the same physical location as the excitation.

By observing the trends of this measurement in polar coordinates in Figure 3.9, a further understanding of its characteristics can be gained. When the magnitude is displayed in log format (dB), anti-resonances occur between every resonance throughout the frequency range. The individual SDOF systems sum to 0 at the frequencies where the mass and stiffness lines of adjacent modes intersect since all the modes are in phase with each other. This results in the near 0 magnitude of an anti-resonance. Also notice the phase lead as the magnitude passes through an anti-resonance and the opposite phase lag as the magnitude passes through a resonance. These trends of the driving point measurement should be observed and monitored throughout the measurement process as a check for maintaining a consistent set of data.

Figure 3.8
Driving point frequency response

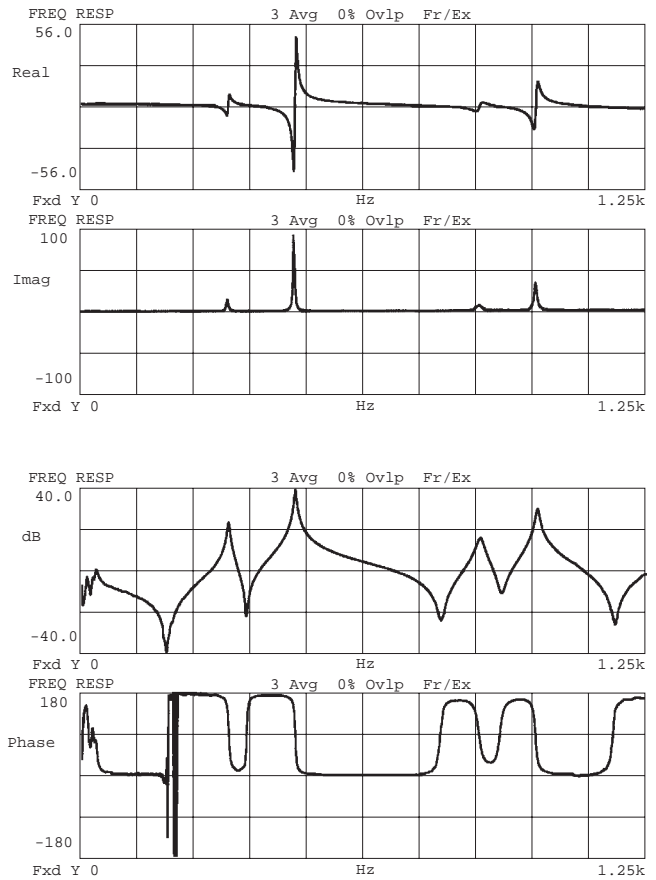
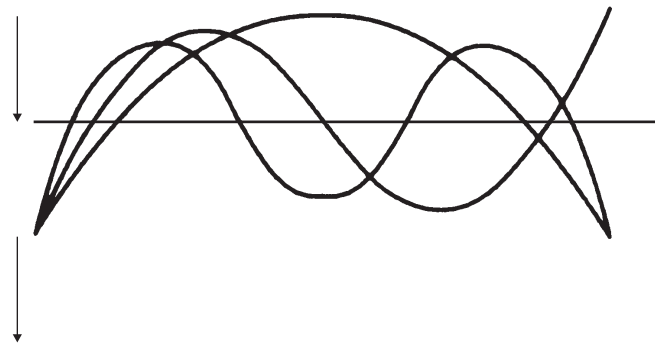

Figure 3.9
Typical free beam mode shapes



The remaining measurements, where the response coordinates are different from the excitation coordinates, are called cross-point measurements. Figure 3.10 illustrates a typical cross-point measurement. All the modes are not necessarily in phase with each other, as seen in the imaginary display. Since the response points are not at the same location as the excitation point, the response can move either in phase or out of phase with the excitation. This motion, which defines the mode shape, is a function of the measurement location, and will vary from measurement to measurement. In the dB display, if any two adjacent modes are in phase at a particular point, then an anti-resonance will exist between them. If any two adjacent modes are out of phase, then their mass and stiffness lines will not cancel at the intersection and a smooth curve will appear instead, as seen in Figure 3.10.

In order to excite all the modes within the frequency range of interest, several shaker or accelerometer locations should be examined. A point or line on the structure that remains stationary is called a node point or node line. The node points of a cantilever beam are illustrated in Figure 3.11. The number and location of these nodes are a function of the particular mode of vibration and increase as mode number increases.

Figure 3.10
Cross-point frequency response

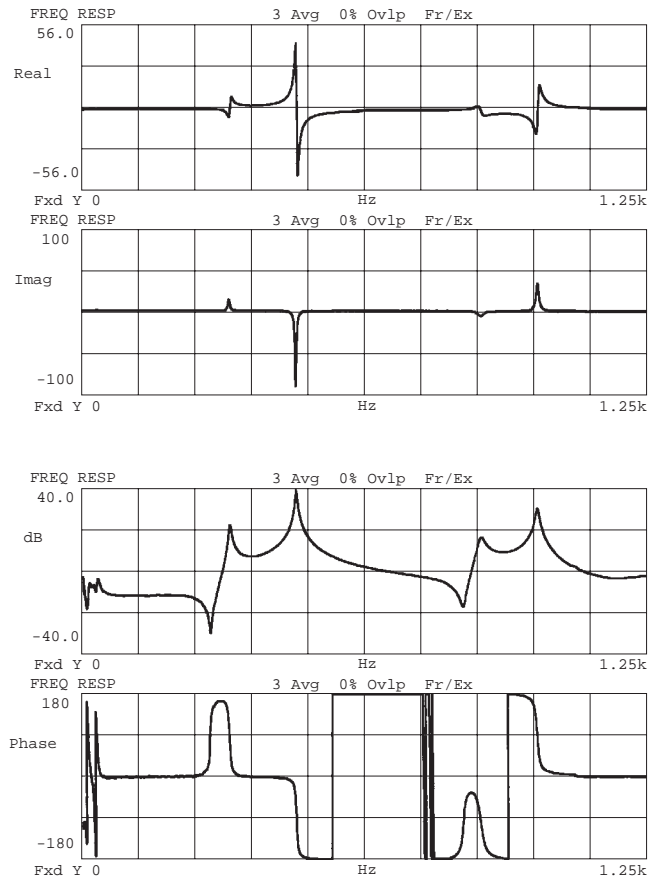
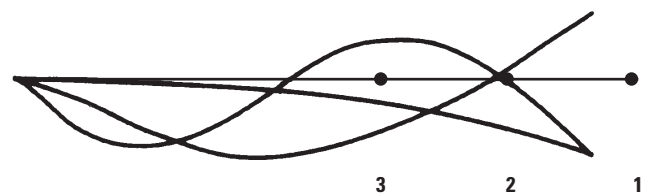

Figure 3.11
Typical cantilever beam mode shapes



If the response is measured at the end of the beam at point 1 and excitation is applied at point 3, all modes will be excited and the resulting frequency response will contain all the modes as shown in Figure 3.10. However, if the response is at point 1 but the excitation is moved to point 2, the second mode will not be excited and the resulting frequency response will appear as shown in Figure 3.12. Referring to Figure 3.11, note that point 2 is a node point for mode 2 and very near a node point for mode 3. Mode 2 does not appear in the imaginary display and mode 3 is barely discernible. In dB coordinates, the mode 3 appears to exist but it is still difficult to observe mode 2. It may be advisable or necessary at times to gather more than one set of data at different excitation locations in order to measure all the modes. It should also be noted that the same observations can be made in an impact test where the response point would also be moved to various locations.

Another concept associated with a linear structure concerns a property of the frequency response matrix. The frequency response matrix for a linear system can be shown to be symmetric due to Maxwell's Reciprocity Theorem. Simply stated, a measurement with the excitation at point i and the response at point j is equal to the measurement with the excitation at point j and the response at point i . This is illustrated in Figure 3.13. A check can be made on the measurement process by comparing these two reciprocal measurements at various pairs of points and observing any differences between them. This can be helpful for noting nonlinearities when applying different force levels.

Figure 3.12
Frequency response with excitation at node of vibration

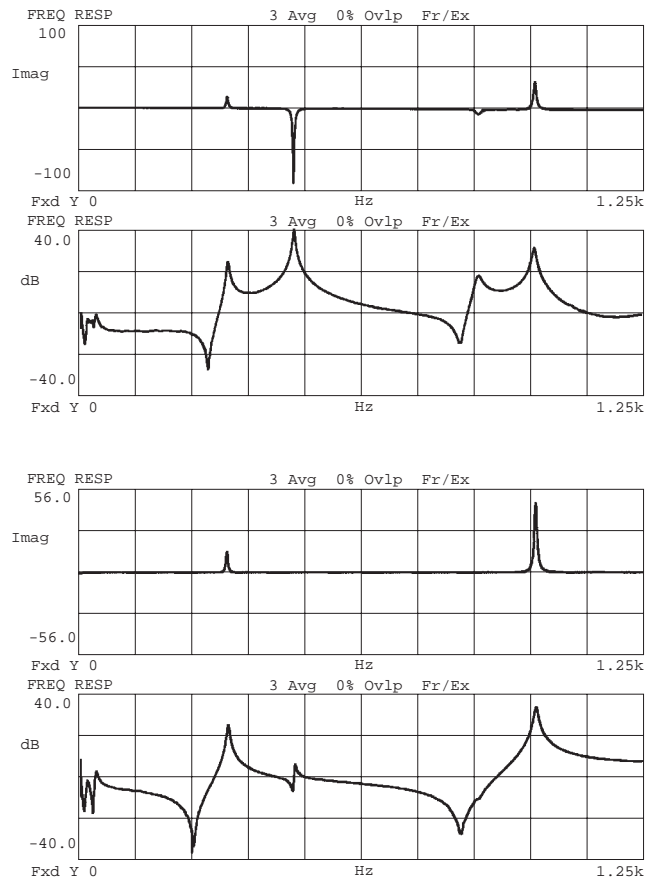
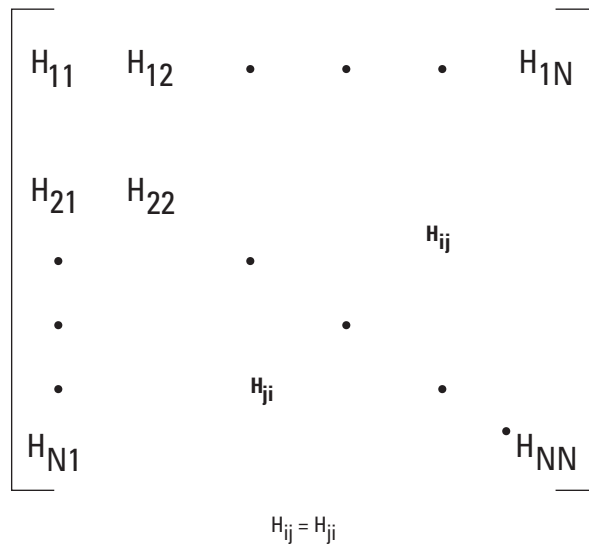

Figure 3.13
Symmetric frequency response matrix



Chapter 4

Modal Parameter Estimation

Introduction

The previous chapter presented several techniques for making frequency response measurements for modal analysis. Having acquired this data, the next major step of the process is the use of parameter estimation techniques – “curve fitting” – to identify the modal parameters. A vast amount of literature exists on the subject of curve fitting measured data to estimate the modal properties of a structure. However, this information tends to be mathematically vigorous and is generally biased toward a particular type of algorithm. It is the intent of this chapter to categorize, in a conceptual manner, the different types of curve fitters and discuss the applications and problems associated with those most commonly implemented.

It was discussed earlier that a minimum of one row or column of the frequency response matrix, or its equivalent, must be measured in order to identify a complete set of modal parameters. Although additional data is, in principle, redundant information, it can be used to verify

and increase the confidence level of the estimated parameters. The frequency and damping for each mode can be estimated from any combination of these measurements. The residues and, consequently, the modal coefficients are then computed for each measurement point. The mode shapes are then scaled and sorted for each resonant frequency. Finally, the modal mass and stiffness can be determined from these scaled parameters as illustrated in Figure 4.1.

Figure 4.1
Typical flow
of modal test

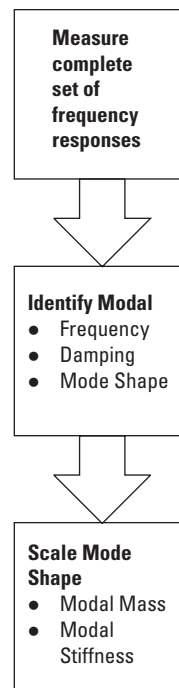

Modal Parameters

One of the most fundamental assumptions of modal testing is that a mode of vibration can be excited at any point on the structure, except at nodes of vibration where it has no motion. This is why a single row or column of the frequency response matrix provides sufficient information to estimate modal parameters. As a result, the frequency and damping of any mode in a structure are constants that can be estimated from any one of the measurements as shown in Figure 4.2. In other words, the frequency and damping of any mode are global properties of the structure.

In practical applications, it is important to include sufficient points in the test to completely describe all the modes of interest. If the excitation point has not been chosen carefully or if enough response points are not measured, then a particular mode may not be adequately represented. At times it may become necessary to include more than one excitation location in order to adequately describe all of the modes of interest. Frequency responses can be measured independently with single-point excitation or simultaneously with multiple-point excitations.

The mode shapes as a whole are also global properties of the structure, but have relative values depending on the point of excitation and scaling and sorting factors. On the other hand, each individual modal coefficient that makes up the mode shape is a local property in the sense that it is estimated from the particular measurement associated with that point as shown in Figure 4.3.

Figure 4.2
Concepts of modal parameters

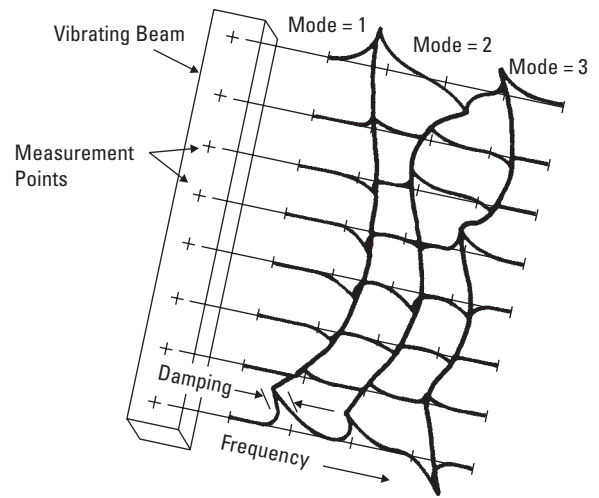

Damping, frequency — same at each measurement point
Mode shape — obtained at same frequency from all measurement points

Figure 4.3
Modal parameters

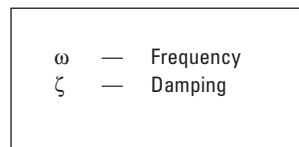

Global

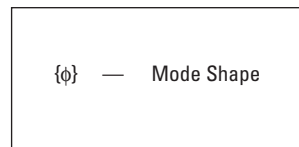

Local

Curve Fitting Methods

Due to the large amount of literature and algorithms currently available for curve fitting structural data, it has become difficult to determine the exact need for each method and which method is best. There is no ideal solution and the common methods are only approximations. Also, many of the methods are very similar to each other and, in some cases, simply extensions of a few basic techniques.

Although there are several ways in which curve fitting methods can be categorized, the most straightforward is single-mode versus multiple-mode classification. Besides the intuitive reasoning for single- and multiple-mode approximations, there are some practical reasons for this classification. The major difference in the level of sophistication, or level of accuracy, among curve fitters is between a single-mode and a multiple-mode method. Also, the computing resources needed (computation speed, memory size and I/O capability) for multiple-mode methods can increase tremendously. Other sub-categories and extensions that fall mostly within multiple-mode methods are shown in Figure 4.4.

Users generally fall into one of three major groups. The first group is primarily concerned with troubleshooting existing mechanical equipment. They are usually concerned with time and require a fast, medium quality curve fitter. The second group is more serious about quantitative parameter estimates for use in a

modal model. For example, they require more accuracy and are willing to spend more time obtaining results. The final group is pushing the state of the art and is involved with development work. Accuracy, rather than time, is of paramount importance.

Figure 4.4
Increasing accuracy in curve fit methods

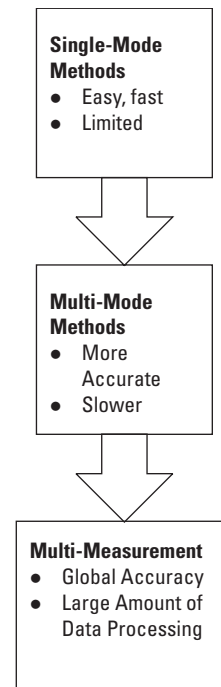

Single-Mode Methods

As stated earlier, the general procedure for estimating modal parameters is to estimate frequencies and damping factors, then estimate modal coefficients. For most single-mode parameter estimation techniques, however, this is not always the case. In fact, it is not absolutely necessary to estimate damping in order to obtain modal coefficients. This is typical in a troubleshooting environment where frequencies and mode shapes are of primary concern.

The basic assumption for single-mode approximations is that in the vicinity of a resonance, the response is due primarily to that single mode. The resonant frequency can be estimated from the frequency response data (illustrated in Figure 4.5) by observing the frequency at which any of the following trends occur:

- The magnitude of the frequency response is a maximum.
- The imaginary part of the frequency response is a maximum or minimum.
- The real part of the frequency response is zero.
- The response lags the input by 90° phase.

It was discussed earlier that the height of the resonant peak is a function of damping. The damping factor can be estimated by the half-power method or other related mathematical or graphical method. In the half-power method, the damping is estimated by determining the sharpness of the resonant peak. It can be shown from Figure 4.6 that damping can be related to the width of the

Figure 4.5
Frequency response

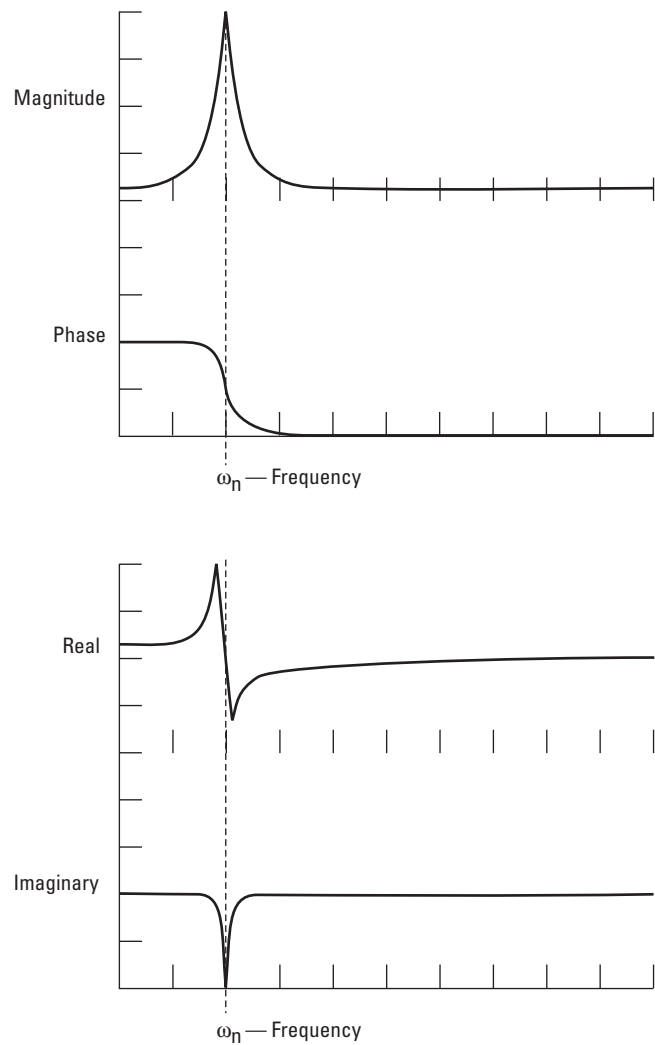

peak between the half-power points: points below and above the resonant peak at which the response magnitude is .7071 times the resonant magnitude.

One of the simplest single-mode modal coefficient estimation techniques is the quadrature method, often called “peak picking”. Modal coefficients are estimated from the imaginary (quadrature) part of the frequency response, so the method is not a curve fit in the strict sense of the term. As mentioned earlier, the imaginary part reaches a maximum at the resonant frequency and is 90° out of phase with respect to the input. The magnitude of the modal coefficient is simply taken as the value of the imaginary part at resonance as illustrated in Figure 4.7. The sign (phase) is taken from the direction that the peak lies along the imaginary axis, either positive or negative. This implies that the phase angle is either 0° or 180°.

The quadrature response method is one of the more popular techniques for estimating modal parameters because it is easy to use, very fast and requires minimum computing resources. It is, however, sensitive to noise on the measurement and effects from adjacent modes. This method is best suited for structures with light damping and well separated modes where modal coefficients are essentially real valued. It is most useful for troubleshooting problems, however, where it is not necessary to create a modal model and time is limited.

Figure 4.6
Damping factor from half power

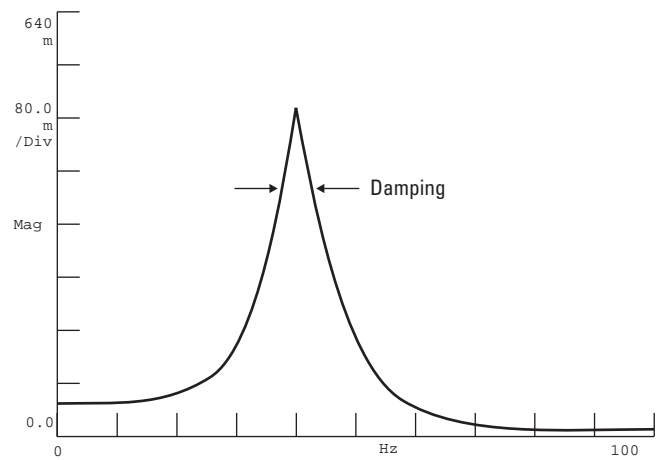

Figure 4.7
Quadrature peak pick

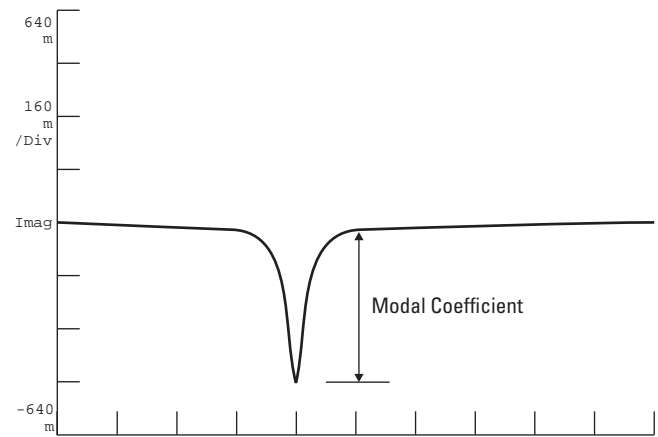
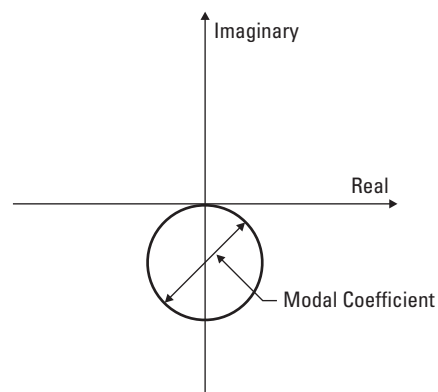

Figure 4.8
Circle fit method



Another single-mode technique, called the circle fit, was originally developed for structural damping but can be extended to the viscous damping case. Recall from Chapter 1 that the frequency response of a mode traces out a circle in the imaginary plane. The method fits a circle to the real and imaginary part of the frequency response data by minimizing the error between the radius of the fitted circle and the measured data. The modal coefficient is then determined from the diameter of the circle as illustrated in Figure 4.8. The phase is determined from the positive or negative half of the imaginary axis in which the circle lies.

Frequency and damping can be estimated by one of the methods discussed earlier or by some of the MDOF methods to be discussed later. Damping can also be estimated from the spacing of points along the Nyquist plot from the circle.

The circle fit method is fairly fast and requires minimum computer resources. It usually results in better parameter estimates than obtained by the quadrature method because it uses more of the measurement information and is not as sensitive to effects from adjacent modes as illustrated in Figure 4.9. It is also less sensitive to noise and distortion on the measurement. However, it requires much more user interaction than the quadrature method; consequently, it is prone to errors, particularly when fitting closely spaced modes.

A SDOF method related to the circle fit is a frequency domain curve fit to a single-mode analytical expression of the frequency response. This expression is generally formulated as a second order polynomial with residual terms to take into account the effects of out of band modes. Because of its similarities to the circle fit, it possesses the same basic advantages and disadvantages.

Concept of Residual Terms

Before proceeding to multiple-mode methods, it is appropriate to discuss the residual effects that out-of-band modes have on estimated parameters. In general, structures possess an infinite number of modes. However, there are only a limited number that are usually of concern. Figure 4.10 illustrates the analytical expression

Figure 4.9
Comparison of quadrature and circle fit methods

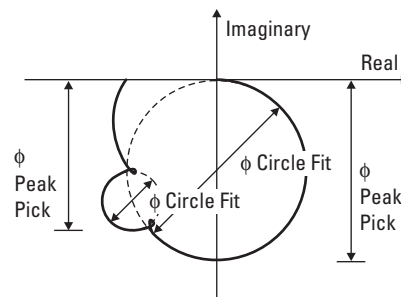

Figure 4.10
Analytical expression of frequency response

$$H(\omega) = \sum_{r=1}^n \frac{\phi_i \phi_j}{(\omega_n^2 - \omega^2) + j(2\zeta\omega\omega_n)}$$

for the frequency response of a structure taking into account the total number of realizable modes. Unfortunately, the measured frequency response is limited to some frequency range of interest depending on the capabilities of the analyzer and the frequency resolution desired. This range may not necessarily include several lower frequency modes and most certainly will not include some higher frequency modes. However, the residual effects of these out-of-band modes will be present in the measurement and, consequently, affect the accuracy of parameter estimation.

Although parameters of the out-of-band modes cannot be identified, their effects can be represented by two relatively simple terms. It can be seen from Figure 4.11 that the effects of the lower modes tend to have mass-like behavior and the effects of the higher modes tend to have stiffness-like behavior. The analytical expression for the residual terms can then be written as shown in Figure 4.12. Notice that the residual terms are equivalent to the asymptotic behavior of the mass and stiffness of a SDOF system discussed in the chapter on structural dynamics.

Useful information can often be gained from the residual terms that has some physical significance. First, if the structure is freely supported during the test, then the low frequency residual term can be a direct measure of rigid body mass properties of the structure. The high frequency term, on the other hand, can be a measure of the local flexibility of the driving point.

Figure 4.11
Single mode summation of frequency response

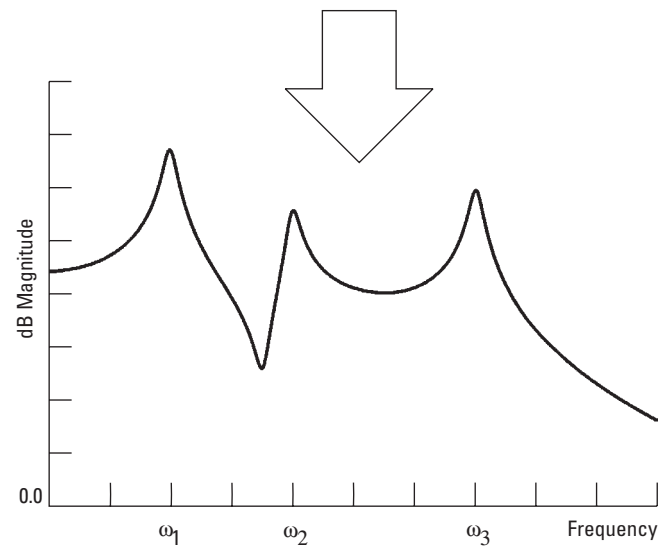
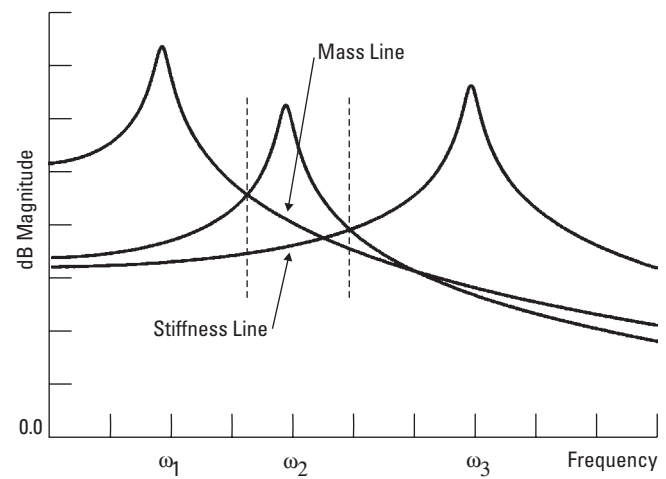

Figure 4.12
Residual terms of frequency response

$$H(\omega) = \frac{\phi_i \phi_j}{-w^2 m} \quad \text{Lower Modes}$$

$$H(\omega) = \frac{\phi_i \phi_j}{k} \quad \text{Higher Modes}$$

Multiple-Mode Methods

The single-mode methods discussed earlier perform reasonably well for structures with lightly damped and well separated modes. These methods are also satisfactory in situations where accuracy is of secondary concern. However, for structures with closely spaced modes, particularly when heavily damped, (as shown in Figure 4.13) the effects of adjacent modes can cause significant approximations. In general, it will be necessary to implement a multiple-mode method to more accurately identify the modal parameters of these types of structures.

The basic task of all multiple-mode methods is to estimate the coefficients in a multiple-mode analytical expression for the frequency response function. This is done by curve fitting a multiple-mode form of the frequency response function to frequency domain measurements. An equivalent method is to curve fit a multiple response form of the impulse response function to time domain data. In either process, all the modal parameters (frequency, damping and modal coefficient) for all the modes are estimated simultaneously.

There are a number of multiple-mode methods currently available for curve fitting measured data to estimate modal parameters. However, there are essentially two different forms of the frequency response function which are used for curve fitting. These are the partial fraction form and the polynomial form which are shown in Figure 4.14. They are equivalent analytical forms and can

Figure 4.13
Damping and modal coupling

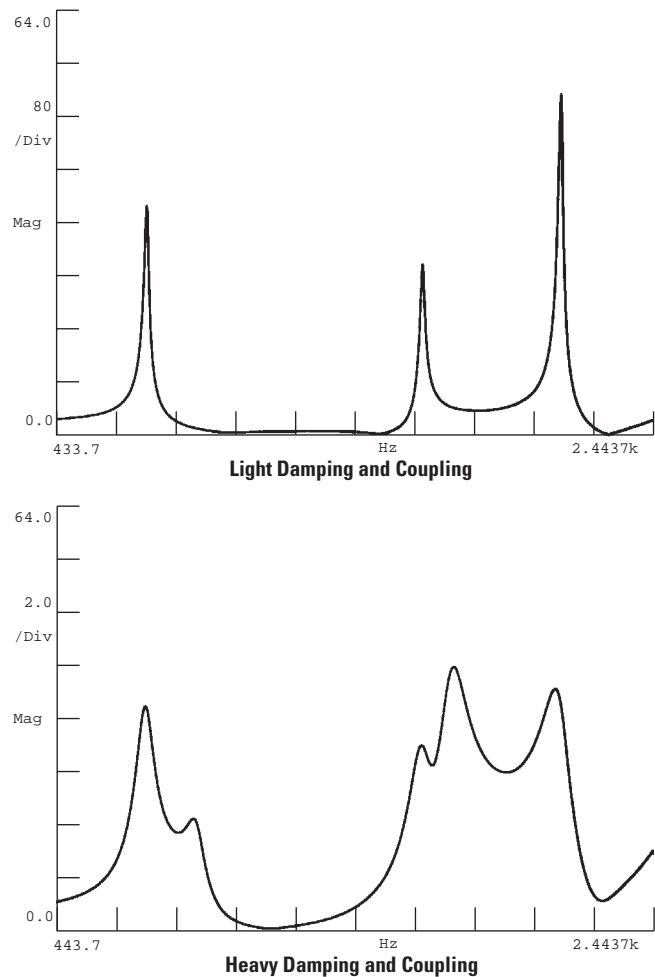

Figure 4.14
Frequency response representation

$$H(\omega) = \sum_{k=1}^n \frac{r_k}{j\omega - p_k} + \frac{r_k^*}{j\omega - p_k^*} \quad \text{Partial Fraction}$$

$$H(\omega) = \frac{a_p s^m + a_{p-1} s^{m-1} + \dots}{b_p s^n + b_{p-1} s^{n-1} + \dots} \quad \text{Polynomial}$$

$$h(t) = \sum_{k=1}^n r_k e^{-\sigma_k t} + r_k^* e^{-\sigma_k^* t} \quad \text{Complex Exponential}$$

be shown to be related to the structural frequency response developed earlier in Chapter 1. The impulse response function, obtained by inverse Fourier transforming the frequency response function into the time domain, is also shown in Figure 4.14.

When the partial fraction form of the frequency response is used, the modal parameters can be estimated directly from the curve fitting process. A least squares error approach yields a set of linear equations that must be solved for the modal coefficients and a set of nonlinear equations that must be solved for frequency and damping. Because an iterative solution is required to solve these equations, there is potential for convergence problems and long computation times.

If the polynomial form of the frequency response is used, the coefficients of the polynomials are identified during the curve fitting process. A root finding solution must then be used to determine the modal parameters. The advantage of the polynomial form is that the equations are linear and the coefficients can be solved by a noniterative process. Therefore, convergence problems are minimal and computing time is more reasonable.

The complex exponential method is a time domain method that fits decaying exponentials to impulse response data. The equations are nonlinear, so an iterative procedure is necessary to obtain a solution. The method is relatively insensitive to noise on the data, but suffers from sensitivity to time domain aliasing, as a result of truncation in the frequency domain from inverse Fourier transforming the frequency responses.

In principle, it should not matter whether frequency domain data or time domain data is used for curve fitting since the same information is contained in both domains. However, there are some practical reasons, based on frequency domain and time domain operations, that seem to favor the frequency domain. One, the measurement data can be restricted to some desired frequency range and any noise or distortion outside this range can effectively be ignored. Another, the cross spectra and autospectra needed to compute frequency responses can be formed

faster than the corresponding time domain correlation functions. It is true that the time domain can be used to select modes having different damping values, but this is usually not as important as the ability to select a frequency range of interest.

Each method has its advantages and disadvantages, but the fundamental problems of noise, distortion and interference from adjacent modes remain. As a result, none of the methods work well in all situations. It is also unlikely that some "magic" method will be discovered that eliminates all of these problems. All of the methods work well with ideal data, but cannot be evaluated by analytical means alone. The important factor is how well they work, or gracefully fail, with real experimental data complete with noise and distortion.

Concept of Real and Complex Modes

The structural model discussed so far is based on the concept of proportional viscous damping which implies the existence of real, or normal, modes. Mathematically, this implies that the physical damping matrix can be defined as linear combination of the physical mass and stiffness matrices as shown in Figure 4.15. The mode shapes, are, in effect real valued, meaning the phase angles differ by 0° or 180° . Physically, all the points reach their maximum excursion at the same time as in a standing wave pattern. One of the consequences of this assumption, discussed earlier, is that the imaginary part of the frequency response reaches a maximum at resonance and the real part is 0 valued as illustrated in Figure 4.16. Note also that the Nyquist circle lies along the imaginary axis.

However, physical structures exhibit a more complicated form of damping which results in non-proportional damping. The mode shapes are, generally, complex valued, meaning the phase angles can have values other than 0° or 180° . Physically, the points reach their maximum excursions at various times as in a traveling wave pattern. With non-proportional damping, the imaginary part of the frequency response no longer reaches a maximum at resonance nor is the real part nonzero valued as illustrated in Figure 4.17. Note also that the Nyquist circle is rotated at an angle in the complex plane.

When damping is light, as is the case in most mechanical structures, the proportional damping assumption is generally an accurate approximation. Although damping is not proportional to the mass and stiffness, the nonproportional coupling effects may be small enough not to cause serious errors. Physically, this means that the damping is sufficiently small so that

coupling is a second-order effect. It should be noted that closely-spaced modes often appear complex as a result of the effects from adjacent modes as illustrated in Figure 4.18. In reality, they may actually be more real than they appear.

Figure 4.15
Proportional damping representation

$$[C] = \alpha [M] + \beta [K]$$

Figure 4.16

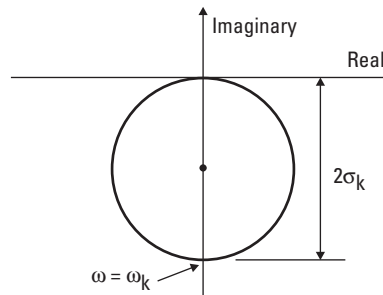

Figure 4.17

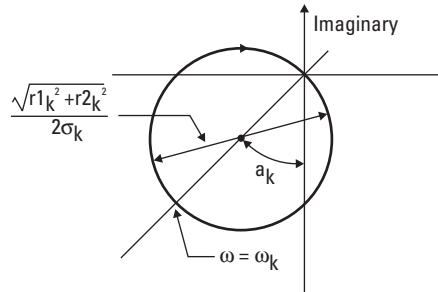
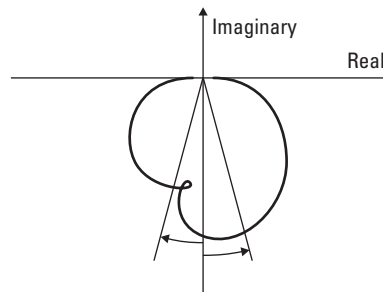

Figure 4.18
Two closely spaced real modes



Chapter 5

Structural Analysis Methods

Introduction

The basic techniques for performing a modal test to identify the dynamic properties of a structure have been described in the previous chapters. An introduction to the applications of the resulting frequency responses and modal parameters is the focus of this chapter. The discussion is specifically concerned with the uses of a response model or a modal model with structural analysis methods as shown in Figure 5.1. The intent is to bring together the experimental and analytical tools for solving noise, vibration and failure problems.

A response model is simply the set of frequency response measurements acquired during the modal test. These measurements contain all the dynamics of the structure needed for subsequent analyses. A modal model is derived from the response model and is a function of the parameter estimation technique used. It not only includes frequencies, damping factors, and mode shapes, but also modal mass and modal stiffness. These masses and stiffnesses depend on the method that was used to scale the mode shapes. A subset of the modal model consisting of only the frequencies and unscaled mode shapes can be useful for some troubleshooting applications where frequencies and mode shapes are the primary concern. However, for applications involving analysis methods, such as structural modification and

Figure 5.1
Alternative types of structural models

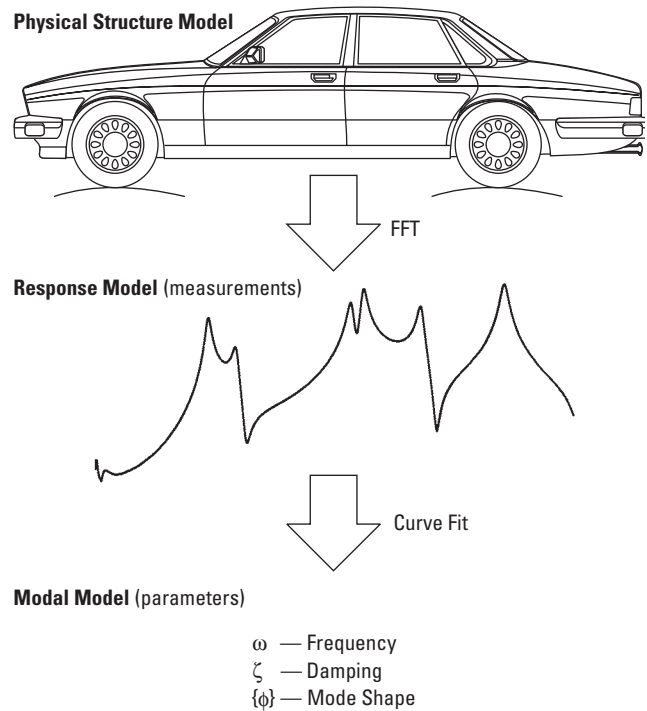

substructure coupling, a complete modal model is required. This definition of a complete modal model should not be confused with the concept of a truncated mode set in which all the modes are not included.

Structural Modification

When troubleshooting a vibration problem or investigating simple design changes, an analysis method known as structural modification, illustrated in Figure 5.2, can be very useful. Basically, the method determines the effects of mass, stiffness and damping changes on the dynamic characteristics of the structure. It is a straightforward technique and gives reasonable solutions for simple design studies. Some of the benefits of using structural modification are reduced time and cost for implementing design changes and elimination of the trial-and-error approach to solving existing vibration problems. The technique can be extended to an iterative process, often called sensitivity analysis, in order to categorize the sensitivity of specific amounts of mass, stiffness or damping changes.

In general, structural modification involves two interrelated design investigations. In the first, a physical mass, stiffness or damping change can be specified with the analysis determining the modified set of modal parameters. The second involves specifying a frequency and having the analysis determine the amount of mass, stiffness or damping needed to shift a resonance to this new frequency. For the user's convenience, specific applications of these basic methods, such as tuned absorber, design are usually included.

Figure 5.2
Structural modification simulation

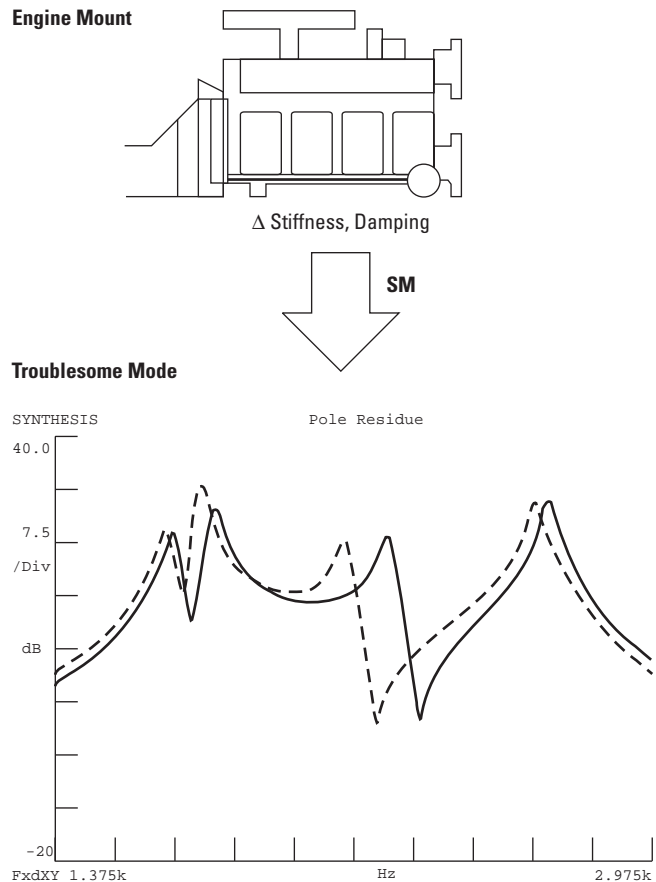

Structural modification can be implemented with either a response model or a modal model. The advantages of response model are that it contains the effects of modes outside the analysis range and the measurements can be limited to the selected set of modified points. It is sensitive, though, to the quality of frequency response measurements and the effects of rigid body modes from

the support system. A modal model requires only one driving point measurement whereas a response model requires a driving point measurement at every location to be modified. The modal model may be more intuitive since it contains direct mass, stiffness and damping information directly. However, it does suffer from being tedious and time consuming to derive and is sensitive to the number and type of modes extracted.

Finite Element Correlation

Finite element analysis is a numerical procedure useful for solving structural mechanics problems. More specifically, it is an analytical method for determining the modal properties of a structure. It is often necessary to validate the results from this theoretical prediction with measured data from a modal test. This correlation method is generally an iterative process and involves two major steps. First, the modal parameters, both frequencies and mode shapes, are compared and the differences quantified. Second, adjustments and modifications are made, usually to the finite element model, to achieve more comparable results. The finite element model can then be used to simulate responses to actual operating environments.

The correlation task is usually begun by comparing the measured and predicted frequencies. This is often done by making a table to compare each mode frequency by frequency as shown in Table 5.1. It is more useful, however, to graphically compare the entire set of frequencies by plotting measured versus the predicted results as shown in Figure 5.3. This shows not only the relative differences between the frequencies, but also the global trends and suggests possible causes of these differences. If there is a direct correlation the points will lie on a straight line with a slope of 1.0. If a random scatter arises, then the finite element model may not be an accurate representation of the structure. This could result from

Table 5.1
Tabular
comparisons
of frequency

FE (Hz)	Test (Hz)
17.5	15.7
21.3	19.4
26.4	25.5
30.0	28.3
31.2	30.5

Figure 5.3
Graphical
comparison
of frequencies

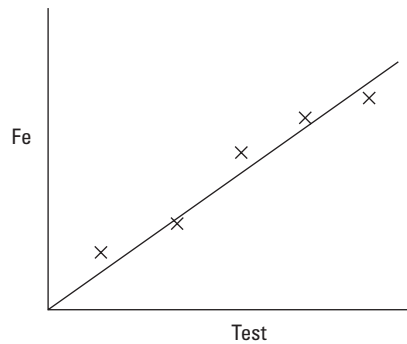

an inappropriate element type or a poor element mesh in the finite element model. It could also result from incorrect boundary conditions in either the test or the analysis. If the points lie on a straight line, but with a slope other than 1, then the problem may be a mass loading problem in the modal test or an incorrect material property, such as elastic modulus or material density, in the finite element model.

The parameter comparison is not actually this simple, nor is it complete, because the mode shapes must also be compared at the same time to

ensure a one-to-one correspondence between the frequency and the mode shape. Remember that a distinct mode shape is associated with each distinct frequency. One technique for performing this comparison is to simply overlay the plotted mode shapes from the test and analysis and observe their general trends. This can become rather difficult, though, for structures with complicated geometry because the plots tend to get cluttered.

Numerical techniques have been developed to perform statistical comparisons between any two mode shapes, illustrated in Figure 5.4. The first results in the modal scale factor (MSF) – a proportionality constant between the two shapes. If the constant is equal to 1.0, this means the shapes were scaled in the same manner such as unity modal mass. If the constant is any value other than 1.0, then the shapes were scaled differently. The second, and more important method, results in the modal assurance criterion (MAC), a correlation coefficient between the two mode shapes. If the coefficient is equal to 1.0, then the two shapes are perfectly correlated. In practice, any value between 0.9 and 1.0 is considered good correlation. If the coefficient is any value less than 1.0, then there is some degree of inconsistency, proportional to the value of the factor, between the shapes. This can be caused by an inaccurate finite element model, as described earlier, or the presence of noise and nonlinearities in the measured data. It should be noted that in order for these comparisons to have a reasonable degree of accuracy, it is very important that coordinate locations in the modal test coincide with coordinates in the finite element mesh.

Figure 5.4
Numerical
comparison of
mode shapes

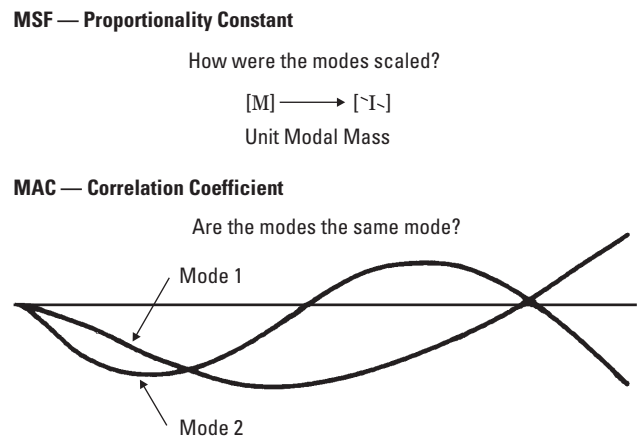

There are other numerical methods for comparing the measured and predicted modal parameters of a structure. One such technique, called direct system parameter identification, is the derivation of a physical model of a structure from measured force and response data. However, techniques such as this are beyond the scope of this text and can be found in technical articles about modal analysis.

Substructure Coupling Analysis

In analyses involving large structures or structures with many components it may not be feasible to assemble a finite element model of the entire structure. The time involved in building the model may be unacceptable and the model may contain more degrees of freedom than the computer can handle. As a result, it may be necessary to employ a modeling reduction method known as substructure coupling or component mode synthesis illustrated in Figure 5.5.

Substructure coupling involves the division of the structure into various components, modeling these components for their individual dynamics and then combining these individual results into one model to analyze the dynamics of the complete structure. These component models can take on several different mathematical forms each of which has a particular usefulness. Common models include modal models and physical models from a finite element analysis, modal models from a modal test, rigid body models and physical springs and dampers. The component models are combined through a transformation that relates their dynamics at the interfaces. The results from the analysis of the complete structure can then be correlated with equivalent modal test results in the same manner as described earlier.

A modal model of a component for substructure coupling must contain the modal mass, stiffness and damping factors along with the modal matrix. The modal matrix of a structure is simply a matrix whose columns are comprised of the respec-

tive modes of the structure. In the special case where the mode shapes have been scaled to unity modal mass, the modal model reduces to the frequencies, damping and mode shapes.

Figure 5.5
Substructure
coupling
analysis

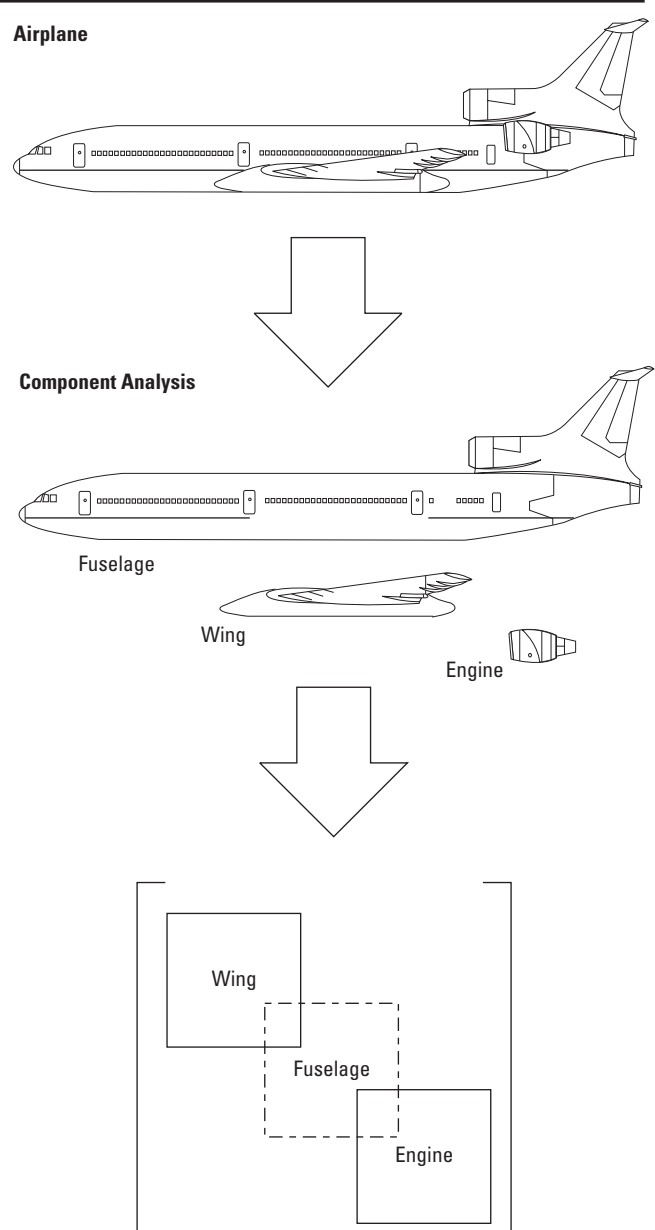

Forced Response Simulation

One of the major design goals for most engineering analyses is to be able to predict system responses to actual operating forces. This can enable engineers to ultimately find optimal solutions to troublesome noise or vibration problems. This technique, illustrated in Figure 5.6, is commonly called forced response simulation or forced response prediction. Forces can be specified for any degree of freedom in the modal model and displacements, velocities or accelerations can be predicted for any degree of freedom.

Figure 5.6
Forced
response
simulation

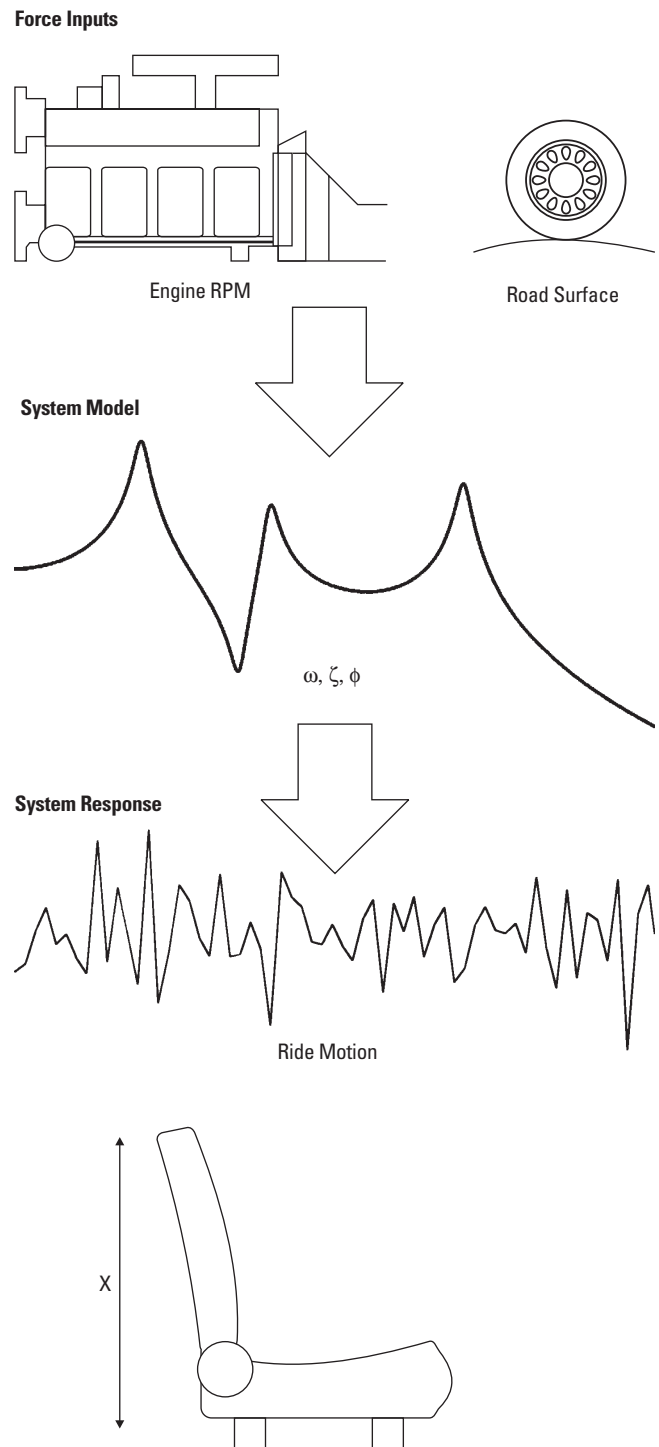

Bibliography

Robert D. Cook
Concepts and Applications of
Finite Element Analysis
John Wiley & Sons
1981

Roy R. Craig, Jr.
Structural Dynamics:
An Introduction to Computer
Methods
John Wiley & Sons
1981

Clare D. McGillem, George R. Cooper
Continuous and Discrete Signal
and System Analysis
Holt, Rinehart, and Winston, Inc.
1974

Francis S. Tse, Ivan E. Morse,
Rolland T. Hinkle
Mechanical Vibrations:
Theory and Applications
Allyn and Bacon, Inc.
1978

D. Brown, G. Carbon, K. Ramsey
Survey of Excitation Techniques
Applicable to Automotive Structures
Society of Automotive Engineers,
#770029
1977

R. J. Allemang, D. L. Brown
A Correlation Coefficient for Modal
Vector Analysis
Proceedings of the 1st International
Modal Analysis Conference
1982

R. J. Allemang, D. L. Brown,
R. W. Rost
Multiple Input Estimation of
Frequency Response Functions
Proceedings of the 2nd International
Modal Analysis Conference
1984

Dave Corelli, David L. Brown
Impact Testing Considerations
Proceedings of the 2nd International
Modal Analysis Conference
1984

Norm Olsen
Excitation Functions for Structural
Frequency Response Measurements
Proceedings of the 2nd International
Modal Analysis Conference
1984

John R. Crowley, G. Thomas Rocklin,
Albert L. Klosterman, Havard Vold
Direct Structural Modification
Using Frequency Response Functions
Proceedings of the 2nd International
Modal Analysis Conference
1984

D. L. Brown, R. J. Allemang,
Ray Zimmerman, M. Mergeay
Parameter Estimation Techniques
for Modal Analysis
Society of Automotive Engineers,
#790221
1979

Richard Jones, Yuji Kobayashi
Global Parameter Estimation
Using Rational Fraction Polynomials
Proceedings of the 4th International
Modal Analysis Conference
1986

Richard Jones, Kathleen Iberle
Structural Modification:
A Comparison of Techniques
Proceedings of the 4th International
Modal Analysis Conference
1986

Agilent Technologies' Test and Measurement Support, Services, and Assistance

Agilent Technologies aims to maximize the value you receive, while minimizing your risk and problems. We strive to ensure that you get the test and measurement capabilities you paid for and obtain the support you need. Our extensive support resources and services can help you choose the right Agilent products for your applications and apply them successfully. Every instrument and system we sell has a global warranty. Support is available for at least five years beyond the production life of the product. Two concepts underlie Agilent's overall support policy: "Our Promise" and "Your Advantage."

Our Promise

Our Promise means your Agilent test and measurement equipment will meet its advertised performance and functionality. When you are choosing new equipment, we will help you with product information, including realistic performance specifications and practical recommendations from experienced test engineers. When you use Agilent equipment, we can verify that it works properly, help with product operation, and provide basic measurement assistance for the use of specified capabilities, at no extra cost upon request. Many self-help tools are available.

Your Advantage

Your Advantage means that Agilent offers a wide range of additional expert test and measurement services, which you can purchase according to your unique technical and business needs. Solve problems efficiently and gain a competitive edge by contracting with us for calibration, extra-cost upgrades, out-of-warranty repairs, and on-site education and training, as well as design, system integration, project management, and other professional engineering services. Experienced Agilent engineers and technicians worldwide can help you maximize your productivity, optimize the return on investment of your Agilent instruments and systems, and obtain dependable measurement accuracy for the life of those products.

For More Assistance with Your Test & Measurement Needs go to

www.agilent.com/find/assist

Or contact the test and measurement experts at Agilent Technologies
(During normal business hours)

United States:
(tel) 1 800 452 4844

Latin America:
(tel) (305) 267 4245
(fax) (305) 267 4286

Canada:
(tel) 1 877 894 4414
(fax) (905) 206 4120

Australia:
(tel) 1 800 629 485
(fax) (61 3) 9272 0749

Europe:
(tel) (31 20) 547 2323
(fax) (31 20) 547 2390

New Zealand:
(tel) 0 800 738 378
(fax) 64 4 495 8950

Japan:
(tel) (81) 426 56 7832
(fax) (81) 426 56 7840

Asia Pacific:
(tel) (852) 3197 7777
(fax) (852) 2506 9284

Product specifications and descriptions in this document subject to change without notice.
Copyright © 1997, 2000 Agilent Technologies
Printed in U.S.A. 5/00
5954-7957E



Agilent Technologies

Innovating the HP Way